

# The Energy Hub – A Powerful Concept for Future Energy Systems

Martin Geidl, Gaudenz Koeppel, Patrick Favre-Perrod, Bernd Klöckl,  
Göran Andersson<sup>1</sup>, Klaus Fröhlich  
Power Systems and High Voltage Laboratories, ETH Zurich, Switzerland

## Introduction

Many of today's energy infrastructures evolved during the second half of the twentieth century and it could be questioned if they meet the requirements of tomorrow. Besides congested transmission systems, many facilities are approaching the end of their prospected life time. In addition to that, other issues such as the continuously growing demand for energy, the dependency on limited fossil energy resources, the restructuring of power industries, and the general aim of utilizing more sustainable and environmentally friendly energy sources raise the question whether piecewise changes of the existing systems are sufficient to cope with all these challenges or a more radical change in system design be needed.

Various scientific studies have investigated future scenarios based on boundary conditions given by today's structures, such as standardized electric voltage and gas pressure levels. Although these studies provide important insights, they often result in solutions that comply with the existing systems; possibly interesting and more long-term oriented solutions are "hidden", as they lie beyond system-given boundaries. In contrast to these studies, a project named *Vision of Future Energy Networks* was initiated at ETH Zurich together with partners<sup>2</sup> that aims at a greenfield approach for future energy supply systems. Restrictions given by the existing systems are basically neglected in order to determine "real" optima. The consideration of multiple energy carriers, not only electricity, represents one of the key characteristic of this project. It is believed that synergies among various forms of energy represent a great opportunity for system improvements. Besides the possibilities of modern information technology, state-of-the-art as well as emerging and looming energy technologies, e.g. fuel cells, are taken into account. The time horizon for implementation is set to 30 to 50 years from now. Thus, the basic question to be answered is: "How should energy systems look like in 30 to 50 years, and what can be expected from them?"

Under these conditions, two key approaches are reasonable: transformation, conversion, and storage of various forms of energy in centralized units called *energy hubs*, and combined transportation of different energy carriers over longer distances in single transmission devices named *energy interconnectors*.

It was soon realized that only a few established tools are available for the integrated analysis of multiple energy carrier systems, thus the project focused in a first phase on developing a modelling and analysis framework. In the second phase, which recently started, optimal system structures and operation strategies are determined and compared with conventional infrastructures using the developed tools. The result of this phase is the greenfield approach. The final phase of the project is dedicated to identifying transition paths and bridging systems leading from today's systems to the identified optimal structures. Figure 1 outlines this process.

---

<sup>1</sup> Corresponding author: g.andersson@ieee.org

<sup>2</sup> The industrial partners sponsoring this project are ABB, Areva, and Siemens. Financial support is also given by BfE, Swiss Federal Office of Energy. Academic partners are RWTH Aachen and TU Delft.

In the remaining part of this paper, the key approaches, some developments as well as some results from the project Vision of Future Energy Networks will be presented. Further general information about the project can be found in references [1], [2], and [3].

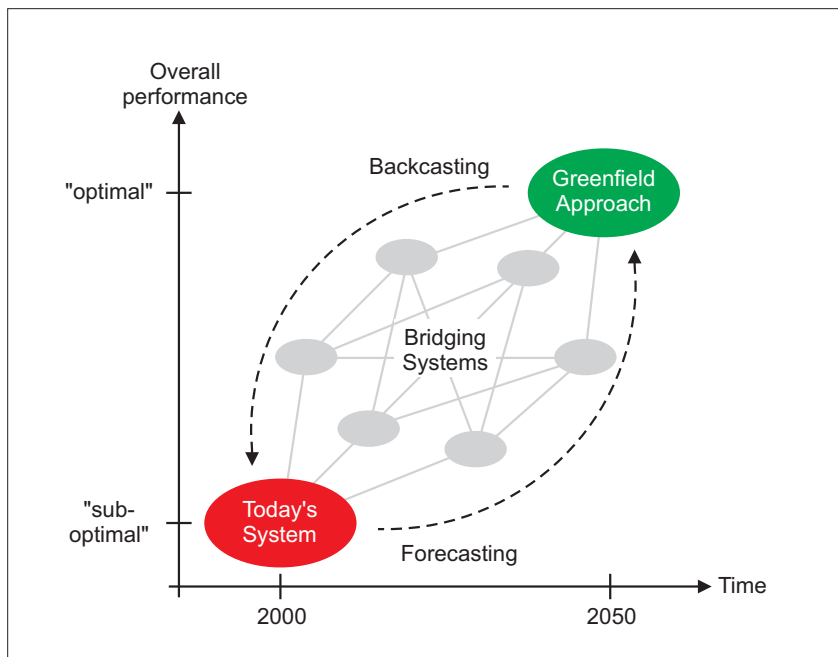

Figure 1: Transition from today's system to the greenfield approach via bridging systems.

## Combining Energy Infrastructures

Industrial, commercial, and residential consumers require various forms of energy services provided by different infrastructures. In the industrialized part of the world, coal, petroleum products, biomass, and grid-bound energy carriers such as electricity, natural gas, and district heating/cooling are typically used. So far, the different infrastructures are most often considered and operated independently. Combining the systems can result in a number of benefits. Synergy effects among various energy carriers can be achieved by taking advantage of their specific virtues: Electricity, for example, can be transmitted over long distances with comparably low losses; chemical energy carriers such as natural gas can be stored employing relatively simple and cheap technology. With so-called line packing techniques compressible fluids can be stored in pipeline networks, even if there are no designated storage devices installed.

Combining the infrastructures means to couple them, thereby enabling exchange of power among them. Couplings are established by converter devices which transform energy into other forms. The question to be answered is of course where to put which devices and how to operate them. Answering this question is essential for the system layout and therefore one of the central issues in the project. Therefore models and methods have been developed to find the optimal coupling and power exchange among multiple energy carriers based on various criteria such as cost, emissions, energy efficiency, availability, security, and other parameters.

## The Energy Hub Concept

A key element in the Vision of Future Energy Networks project is the so-called energy hub. An energy hub is considered as a unit where multiple energy carriers can be converted, conditioned, and stored. It represents an interface between different energy infrastructures

and/or loads. Energy hubs consume power at their input ports connected to e.g. electricity and natural gas infrastructures, and provide certain required energy services such as electricity, heating, cooling, compressed air, etc. at the output ports. Within the hub, energy is converted and conditioned using e.g. combined heat and power technology, transformers, power-electronic devices, compressors, heat exchangers, and other equipment. Real facilities that can be considered as energy hubs are for example industrial plants (steel works, paper mills), larger buildings (airports, hospitals, and shopping malls), rural and urban districts, and island energy systems (trains, ships, and aircrafts). Figure 2 shows an example of an energy hub.

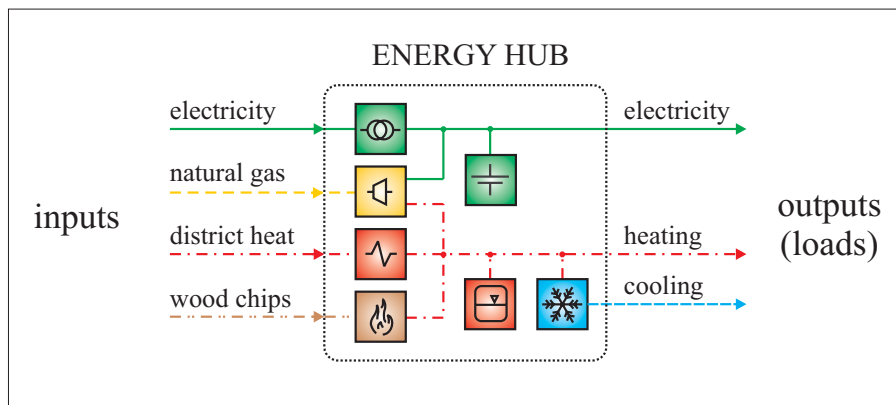

Figure 2: Example of an energy hub that contains a transformer, a micro turbine, a heat exchanger, a furnace, absorption cooler, a battery, and hot water storage.

The components within the hub may establish redundant connections between inputs and outputs. For example, the electricity load connected to the hub in Figure 2 can be met by consuming all power directly from the respective grid or generating part or all of the required electricity from natural gas. This redundancy in supply results in two important benefits which can be achieved using energy hubs. First, reliability of supply can be increased from the load's perspective because it is no longer fully dependent on a single network. Alternatively, reliability of the individual infrastructures could be reduced (e.g. by reducing maintenance) while availability for the load remains high. Second, the additional degree of freedom enables the optimization of the supply of the hub. Energy carriers offered at the hub's input can be characterized based on their cost, related emissions, availability, and other criteria; the inputs can then be optimally dispatched based on these quantities.

Besides that, utilizing energy storage represents an opportunity for increasing the overall system performance therefore storage is already taken into account in the planning phase. Especially when energy sources with stochastically available primary energy (e.g. wind, solar) are considered, storage becomes important since it makes it possible to affect the corresponding power flows. Compensation of fluctuating power flows is possibly the most evident application of energy storage technology. However, investigations have shown that storage can be utilized in such a way that it positively affects all of the aforementioned criteria, especially when considering a liberalized market environment.

## The Interconnector Concept

Integrating different energy carriers is also possible in terms of transmission. In the Vision of Future Energy Networks project, a device named *energy interconnector* is proposed and investigated that enables integrated transportation of electrical, chemical, and thermal energy in one underground device. So far, the most promising layout seems to be a hollow electrical conductor carrying a gaseous medium inside, see Figure 3.

The basic motivation for combined transmission is the possibility of efficiency improvement due to heat recovery. The heat losses generated in the electrical conductor are partially transferred to the gas (whose temperature consequently increases) and could be recovered at the end of the link. Alternatively, losses could be used for increasing the gas temperature before expanding it in order to keep the temperature within required limits.

From an energetic point of view, combined transmission is more efficient if the heat losses can be used at the end of the link. From a legal point of view, the device could be interesting since rights of way and other issues could be managed for electrical and chemical transmission simultaneously. Like normal pipelines, the energy interconnector can also be used for gas storage (“line pack”). A possible disadvantage of combined transmission is the dependability of the interacting power flows (electricity and gas), which could reduce supply redundancy. Considering contingencies on the one hand, common mode failures could be a serious issue. On the other hand, investigations have shown that operational boundaries arise from the coupling of the flows. Simply speaking, a certain gas flow is necessary to provide sufficient cooling for the electrical conductor. Studies have shown that these operational restrictions can be relieved when combining energy interconnectors with energy hubs. However, under certain circumstances the energy interconnector promises better performance than traditional, separated transmission technologies. The integration of gaseous and electrical energy transmission is only one of several possible approaches. Concepts involving liquid chemical carriers or further forms of energy may be advantageous as well.

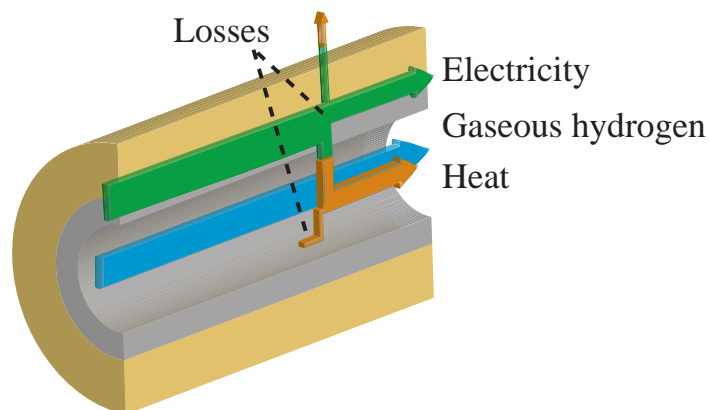

Figure 3: Possible layout of an energy interconnector.

## New Models and Analysis Tools

Economic and physical performances of different energy carriers are well understood, but global features of integrated systems have not been investigated extensively and systematically yet. Since there are only a few established tools available for the analysis of such systems, the development of a modelling and analysis framework for multi-carrier energy systems has been identified as an essential need. The aim was to develop the same tools as are available for electricity systems – e.g. power flow, economic dispatch, reliability, stability, etc. Besides that, models for storage and interconnector technology were developed suitable to be integrated into the system analysis framework.

### Power Flow

For general investigations on the system level, steady state flow models are appropriate and commonly used. The flows through power converter devices can be analyzed by defining their energy efficiency as the ratio of steady state output and input. With multiple in- and outputs, a conversion matrix, or coupling matrix, can be defined which links the vectors of the

corresponding power flows. Figure 4 outlines this modelling concept. The coupling matrix describes the transformation of power from the input to the output of the hub; it can be derived from the hub's converter structure and the converter's efficiency characteristics. Describing the behaviour of storage devices requires the consideration of time and energy as additional variables. Various flow models are available for hydraulic and electric networks, from general network flow to more detailed steady state power flow models. The appropriate degree of approximation depends on the kind of investigation. Combined transmission links (interconnectors) can be modelled similar to energy hubs via coupling matrices. This is further elaborated in reference [5].

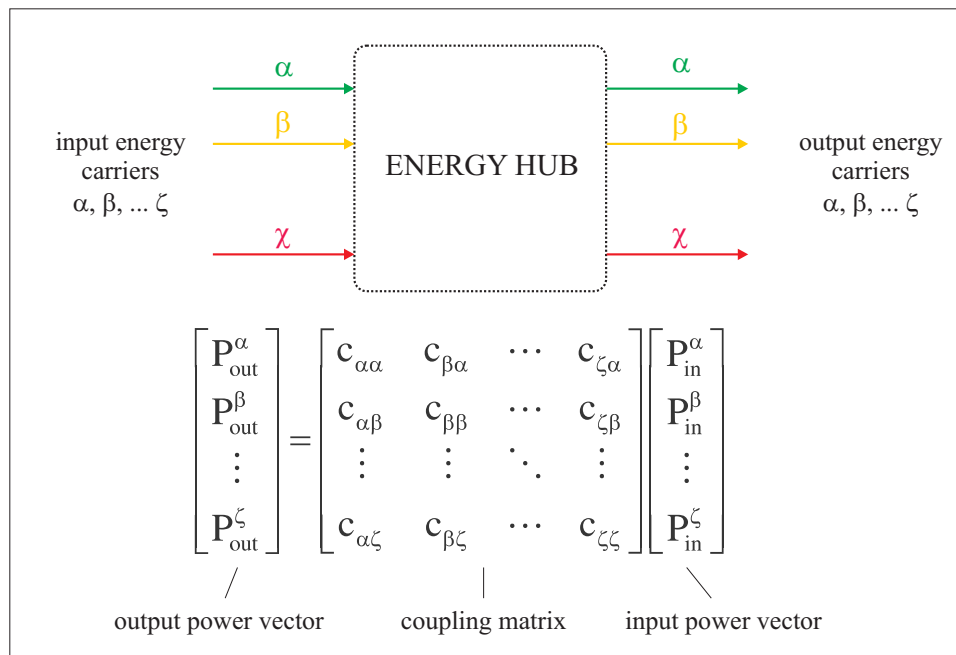

Figure 4: Modelling the transformation of power through an energy hub.

## Reliability

Reliability and availability of energy supply is an important issue, therefore models have also been developed for this kind of investigations. Failure and repair rates can be defined for all components in the system. Considering an energy hub, failure and repair rates of the coupling elements can be stated in matrices similar to the mentioned coupling matrix in Figure 4, and this has been elaborated in [4]<sup>3</sup>. It is out of the scope of this paper to go into the details of such an analysis, but the general conclusions can be illustrated by an example. Figure 5 shows the German standard weekday electrical load profile for a small business, scaled to a total annual consumption of 20 MWh. The electrical load can be supplied by:

Direct electrical connection, capacity  $C_{ee} = 10$  kW

Conversion chemical to electrical, capacity  $C_{ce} = 2$  kW

Conversion thermal to electrical, capacity  $C_{te} = 0.5$  kW

As can be seen from Figure 5 the load can during different time intervals be supplied through different combinations of the three supply channels given above.

<sup>3</sup> Much of the work concerning reliability and storage optimisation was done in collaboration with Norwegian University of Science and Technology, Trondheim.

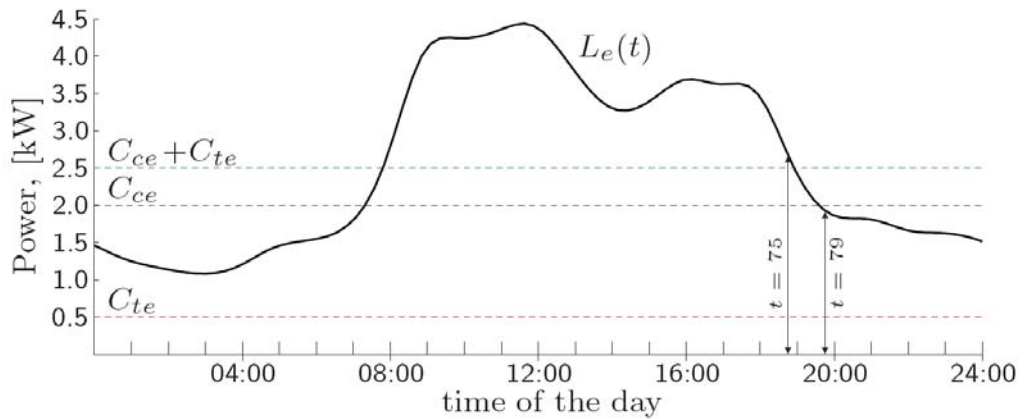

Figure 5: Electrical load curve of a small business of total annual consumption of 20 MWh. Indicated are the capacities of the different converters as given in text.

Obviously the load can be supplied by the electrical connection alone, but during different time intervals the load or part of the load can be supplied by the chemical to electrical connection alone or in combination with the thermal to electrical connection. This will increase the reliability indicators of the system, e.g. the availability and the *Expected Energy Not Supplied*, EENS.

The detailed modelling using Markov techniques and numerous application examples can be found in [4].

## System Optimization

Various optimization problems can be identified when considering integrated multi-carrier systems. The basic question of combined optimal power flow is how much of which energy carriers the hubs should consume and how should they be converted in order to meet the loads at their outputs. This is an operational problem. In the planning phase, the optimal structure of the hub may be of interest, which can be found by determining the optimal coupling matrix which describes the conversions within the hub. Converters can then be selected in order to establish this optimal coupling, and missing technology can be identified. These and other optimization problems have been formulated and analysed using various criteria such as energy cost, system emissions, transmission security measures, etc. Bi- and multi-objective optimization can be performed by combining different criteria in composite objective functions.

In reference [5] the details of the optimization procedure have been described. Here only one interesting result will be highlighted. The relationship between the outputs, i.e. the load vector  $\mathbf{L}$ , and the input vector,  $\mathbf{P}$ , in Figure 4 can in matrix form be written as

$$\mathbf{L} = \mathbf{C}\mathbf{P}$$

where  $\mathbf{C}$  is the coupling matrix in Figure 4. A general optimality condition of the hub can then be written as

$$\Psi = \Lambda\mathbf{C}$$

where  $\Psi$  is the vector of system marginal prices and  $\Lambda$  the vector of hub marginal prices. This latter equation is the equivalent to the well-known economic dispatch rule for generators in electrical systems, the so called “equal incremental cost rule” as illustrated in Figure 6.

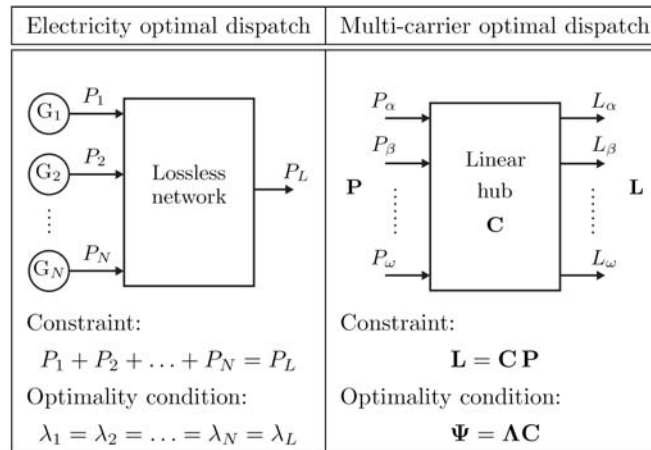

Figure 6: Electricity and multi-carrier optimal dispatch.

### Evaluation of Investment

When talking about completely new systems on the green field, the question of cost comes up immediately. Energy prices and savings in energy cost can be estimated although assumptions are often critical. More difficult is the evaluation of investment costs. How much will new technologies such as fuel cells cost in 30 to 50 years? To avoid speculations based on doubtful assumptions, the question is put differently. The justifiable investment costs are determined by comparing the performances of the conventional and the proposed/assumed system. For example, energy costs and CO<sub>2</sub> taxes can be compared for a conventional system and an optimized greenfield structure. From the annual savings due to higher energy efficiency and less emissions of new technologies, a present value can be determined which represents the break-even investment cost of the new technology. With this method, results still depend on critical assumptions such as inflation, compounding, risk, etc. However, using this tool for sensitivity analysis yields deeper insight into economics; it enables to identify the significant parameters. Figure 7 shows an example where the sensitivity between total energy efficiency of a cogeneration-equipped energy hub and its justifiable investment cost was determined. In this particular case, results show that even today's state-of-the-art technology could keep up with the requirements, i.e. installing such a cogeneration devices would be reasonable from an economic point of view.

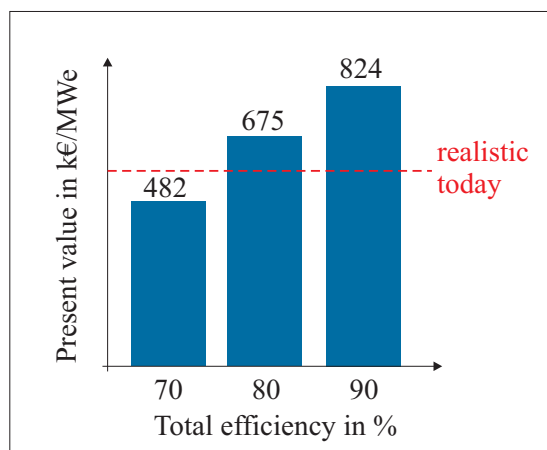

Figure 7: Result of investment analysis. The present value of the device (per MW electrical output) increases with its total efficiency, since more energy cost are saved in each period if the efficiency is higher. Today's investment cost for CHP units of comparable size are in the range of 500 k€ per MW electrical output (rated). The conclusion that can be drawn from this plot is that an investment is reasonable if a total efficiency of more than 75 % can be achieved.

## Applications

The energy hub idea was picked up by a municipal utility in Switzerland, the Regionalwerke AG Baden, which plans to build an energy hub containing wood chip gasification and methanation, and a cogeneration plant. The idea is to generate *Synthetic Natural Gas* (SNG) and heat from wood chips, a resource which is available in the company's supply region. The produced SNG can then either be directly injected in the utility's natural gas system or converted into electricity via a cogeneration unit and fed into the electric distribution network. Waste heat, which accrues in both cases, can be absorbed by the local district heating network. The whole system can be seen as an energy hub processing different energy carriers – wood chips, electricity, heat, and SNG. In addition to these energy carriers, the gasification process requires nitrogen and steam, which have to be provided at the hub input. Figure 8 gives an overview of the hub layout. The new thing here is not the technology used (converters), but its integrated planning and operation which is believed to enable better overall system performance.

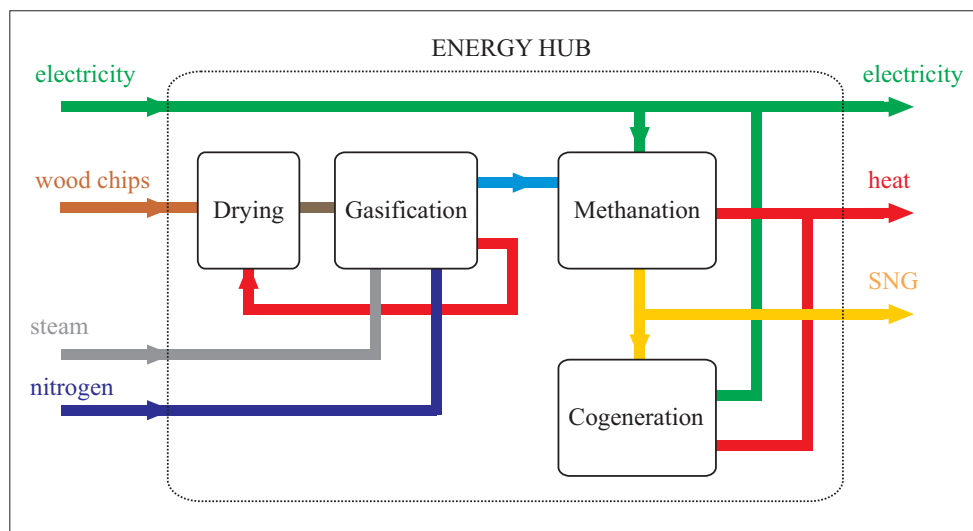

Figure 8: Sketch of the energy hub to be realized by Regionalwerke AG Baden, Switzerland.

The developed multi-carrier analysis tools can be applied to this energy hub in order to answer some fundamental questions, e.g.:

- *Design/Dimensioning* – How should the converters be rated, i.e. how much electricity, SNG, and heat should the hub be able to produce?
- *Operation* – How should the energy hub be operated, how much electricity/SNG/heat should be generated depending on the actual load situation?
- *Storage* – Which and how much of which energy carrier should the energy hub be able to store – wood chips, SNG, heat, electricity?
- *System Impact* – How does the energy hub influence the overall system performance in terms of reliability/availability, energy efficiency, power quality, etc.?

The project is still in the planning phase. A first version of the hub, which only contains wood gasification and cogeneration units, should be realized by 2009. The “full version”, which



then includes also the methanation part (thus enabling infeed of SNG into the natural gas network) should start running in 2011.

## Conclusions

The research project Vision of Future Energy Networks distinguishes itself from others by aiming at a greenfield approach, integrating multiple energy carriers, and considering a timeframe of 30 to 50 years from now. The definition of energy hubs and the conception of combined interconnector devices represent key approaches towards a multi-carrier greenfield layout. Models and tools for technical (e.g. power flow, reliability), economical (e.g. energy and investment cost), and environmental (e.g. CO<sub>2</sub> emissions) investigations in multi-carrier energy systems have been developed and used in various case studies. The main conclusions that can be drawn so far are:

- The energy hub concept enables new design approaches for multiple energy carrier systems.
- The flexible combination of different energy carriers using conversion and storage technology keeps potential for various system improvements. Energy cost and system emissions can be reduced, security and availability of supply can be increased, congestion can be released, and overall energy efficiency can be improved.
- The developed modelling and analysis framework provides suitable tools for the planning and operation of multiple energy carrier systems.

Future work includes the development of dynamic modelling and analysis tools (e.g. for evaluating stability), and the control of a system of interconnected energy hubs (centralized versus decentralized, agent-based, etc.). A further activity just started concerns the risk analysis, including financial risks, of the system. The concepts will be further refined and elaborated in more detail using realistic examples and case studies.

## References

- [1] *Vision of Future Energy Networks*. Project Homepage, available on <http://www.eeh.ee.ethz.ch/psl/research/vofen.html>
- [2] P. Favre-Perrod, M. Geidl, G. Koepfel, B. Klöckl: *A Vision of Future Energy Networks*. IEEE Inaugural Conference and Exposition in Africa, Durban, South Africa, 2005.
- [3] M. Geidl, P. Favre-Perrod, B. Klöckl, G. Koepfel: *A greenfield approach for future power systems*. CIGRE Session 41, Paris, France, 2006.
- [4] G. Koepfel: *Reliability Considerations of Future Energy Systems: Multi-Carrier Systems and the Effect of Storage*. PhD thesis, ETH Zürich, February 2007
- [5] M. Geidl and G. Andersson; *Optimal Power Flow of Multiple Energy Carriers*, IEEE Transactions on Power Systems, Vol. 22, No. 1, February 2007, pp 145 - 155

## Acknowledgement

Financial support from ABB, Areva, Siemens, and the Swiss Federal Office of Energy is gratefully acknowledged.

## Biographies

**Martin Geidl** received a Dipl.-Ing. degree in electrical engineering from the Graz University of Technology, Austria, in 2003. After that he joined the Power Systems Laboratory of ETH Zurich, Switzerland, where he is working towards a PhD. Martin Geidl is a student member of the IEEE.

**Gaudenz Koepfel** received his MS in electrical engineering from ETH Zurich, Switzerland, in 2002. He is currently pursuing his PhD degree at the Power Systems Group at ETH Zurich. Gaudenz Koepfel is a student member of the IEEE.

**Patrick Favre-Perrod** graduated from ETH Zurich, Switzerland in 2003. He is currently working on a thesis about energy transmission in future power systems at the high voltage laboratory of ETH Zurich. Patrick Favre-Perrod is a student member of the IEEE.

**Bernd Klöckl** received his MSc degree from Graz University of Technology, Austria, in the areas of electric machines and high voltage technology in 2001. Since 2002 he is with the High Voltage Laboratory of ETH Zurich, Switzerland. Bernd Klöckl is a student member of the IEEE.

**Göran Andersson** obtained his MSc and PhD degree from the University of Lund in 1975 and 1980, respectively. In 1980 he joined ASEA, now ABB, HVDC division in Ludvika, Sweden, and in 1986 he was appointed full professor in electric power systems at the Royal Institute of Technology (KTH), Stockholm, Sweden. Since 2000 he is full professor in electric power systems at ETH Zurich, Switzerland, where he heads the Power Systems Laboratory. Göran Andersson is a Fellow of the IEEE and the past chair of the IEEE PES Power System Dynamic Performance Committee.

**Klaus Fröhlich** received the M.Eng. and Ph.D. degrees in Technical Science from the Vienna University of Technology, Austria. After 11 years in Switchgear and High Voltage Technology with BBC (later ABB) in Switzerland, he became a full professor at the Vienna University of Technology in 1990. Since 1997 he has been a full professor of High Voltage Technology at the Swiss Federal Institute of Technology Zurich, Switzerland. Klaus Fröhlich is a fellow of the IEEE and chairs the CIGRE Technical Committee.