

RIGBY'S

Easy to Build **MODELS OF**

WARPLANES

OF THE WORLD 2ND SERIES



**COMPLETE
WITH ALL
PARTS**

A Restoration
Of The 1943 Rigby
Paper-Model Book
Copyright © 1993 FLYN THINGS™



**16 FINE SCALE MODELS
10 THAT ACTUALLY FLY**
**INSTRUCTIVE AND ENTERTAINING
CAN BE ASSEMBLED BY ANYONE**

Rigby's WWII Flying Paper Models

Paper models of all types are popular in many countries. Called Paper-Card Modeling in Europe, it spans the range from simple folded-paper darts, to complex three-dimensional models of airplanes, ships and buildings.

The paper-plane construction style of this book was developed by Wallis Rigby, an Englishman. He was internationally known for his paper models of airplanes, ships and trains. This is one of Rigby's many books of paper-model WWII airplanes. Rigby is generally credited with developing and popularizing the tab-and-slot type of paper-model construction. This simplified construction gave thousands of young modelers their first experience with model airplanes.

This book contains all of the original's flying models. The rest of the book contained color-printed, die cut, display models. A future project is to restore these models, too.

The Simple Tools Needed

Most of what you'll need is already on hand. Just scissors, a single-edge razor blade and some glue will do. However, we do have some suggestions to make it easy. Please follow the step-by-step instructions.

As Rigby noted;

"I repeat as a final caution, follow the instructions on page 2, as well as the special notes which appear with the models themselves and **MAKE TRIAL ASSEMBLIES BEFORE FINALLY GLUING DOWN.**

You will be delighted with the result and will be well rewarded in hours of fun for the time you have spent in this interesting and instructive hobby".

The best method of gluing laminated (folded) parts together is with an ordinary glue stick — Dennison's brand works well. Remember, that paper absorbs water and warps; **DO NOT LAMINATE THESE PARTS WITH WATER-BASED GLUE!** In all cases, weight down the laminated parts and let dry. The parts must be perfectly flat.

Please see our **Building Tips**.

Build, Fly and above all, HAVE FUN!

Phil Koopman, Sr.

[☐ Table Of Contents](#)



FLY'N THINGS™ Rigby Book 1 WWII Flying Models

What You'll Need

For printing the models, you'll need a few 8-1/2" x 11" sheets of heavy paper or 67-pound Vellum Bristol. Most office supply stores carry it. One brand is Wausau Paper's Exact® Vellum Bristol. If you can't find the Vellum Bristol, use smooth paper from an artist's pad that's about the thickness of a post card. Or, try your local print shop. For instruction sheets, the regular paper you use in your printer is fine.

General Printing Information

The **FLY'N THINGS™ Rigby Book 1 WWII Flying Models** have been tested with an HP LaserJet III, a LaserJet III/Adobe Postscript™, and a Canon BJC-800 CMYK color printer, running under Windows® 3.1, 3.11 and Windows® 95. and MS-DOS® 6.x. The fine-line quality will depend on the resolution of your particular printer. And, some versions of the Adobe Acrobat Reader, like Version 1.0 for DOS, may not support all printers. Or, support some, like color bubble-jets, for monochrome-only printing.

All sheets have been sized to allow extra margin for some ink-jet printers, like the HP Deskjets, that need extra space at the bottom of the sheet. The Model sheets are in black-and-white as were the originals. They have been reduced in size (70% of the original) so you can use your present printer with standard letter-size paper.

Each sheet of drawings has an precise-size border. You can enlarge the sheets to a bit over 90% with a copier that uses 11-x 17-inch paper. If you use the automatic enlargement feature of a copier, the borders should insure that multi-sheet models, like the Lancaster Bomber, enlarged to the same size.

When printing card stock on any printer, make sure you follow the maker's instruction — check your printer manual. For some Ink Jets, you may have to "Help" it feed the paper. For most laser printers, open the back door and setup for a "straight-through" paper path. If your printer can't handle card stock, print the image on thin paper with a smooth finish, like Hammermill Laser Print. Then, laminate the paper to the card stock with a glue stick; Dennision's brand works well. Or, print on paper and then use a copy machine to copy your printed image to the card stock.

Printing Setup

To print these samples, setup your DEFAULT Windows Printer for LANDSCAPE mode, 8-1/2" x 11" paper, and high-quality printing. The samples are viewed/printed with Adobe Reader. Make sure you use the highest resolution for your printer. And, set to print the current page. The Adobe PDF printer control automatically centers the image on the printed page if you check the "Shrink To Fit" box. Please CHECK the printer-resolution setting in Adobe-Reader Print Dialog box before printing, as it overrides the printer control-panel's settings!

Please Note:

The **QUALITY** of the printed image depends on the resolution of your printer. The higher the printer resolution, the better the printed image will be. If you have difficulty in printing, check

that you are using the latest version of your printer driver. We have found that some print drivers, like the original 8-bit driver for the Canon BJC-800, can skip patches of the image when printing from the Adobe Acrobat™ Reader.

❑ [Click For Information On Printing Problems](#)

True Waterproof Ink-Jet Printing!

After almost two years of experimenting with color ink-jet printing we have at last found a solution. We are now able to supply special, imported, card stock and paper for color ink-jet printing that is REALLY waterproof - Not just smudge proof. You can actually soak it in water without bleeding! **No special inks or cartridge reloading is needed!! We have extensively tested this paper with Canon Bubble-Jet printers. It should work with most other color ink-jet printers, but with the wide variety of printers available it's impossible for us to test them all. Please see the order blank for prices and shipping charges. If in doubt order the sample pack to try on your ink-jet printer.**

Coloring The Models.

Coloring your models depends on how you printed it. If you use a laser printer, then the black image is waterproof. You can use about any type of color that doesn't contain a solvent that "melts" the laser printer's wax/carbon image. Check a small section of the title to make sure before starting to color your model. If you use water colors, apply a light "dry" coat — too much water causes the paper to warp. Many of the water-color markers work fine, just apply light coats so you don't soak the paper.

For water-proof Ink-Jet images, you can use either water- or solvent-based markers pens or colors. Again, make sure that you don't saturate the paper so that it warps. A few light coats, with time to dry between applications works well. If your Ink-Jet image isn't waterproof then you must use solvent-based colors — water-based colors make the ink-jet's black image run and spoil your work.

Another method of getting a colored model is to print on colored paper. Most card stock, like Wausau Paper's Exact(r) Vellum Bristol, and heavy paper — generally called cover stock — comes in a wide range of colors. Fill in details, like windows and insignia with either colored paper or opaque colors.

Building Tips

Cutting And Folding Parts

Step 2 shows how to make a suitable cutting pad. Even the back of a paper tablet will work. You need a have a flat, smooth surface to cut and assemble on. And, make sure it's thick enough so you don't cut through and ruin your work table. We generally use on one of the new self-healing 11x17 inch cutting mats.

❑ [Table Of Contents](#)



Use a model knife, or even a small disposable type, with a triangular blade for cutting out the parts. If available, use the “scalpel” type knife as it has a thin blade. Small scissors are useful for cutting curves, like wing tips. A “straight” metal straight edge as a cutting guide makes it easy to trim parts to shape. For easy building, please follow our instructions: Score on the dashed lines, then cut out the parts.

Cutting Boards

The main thing is to have a flat, smooth surface to cut and assemble on. And, make sure it’s thick enough so you don’t cut through and ruin your work table. If you use heavy card stock, like the back of a tablet, just tape together several layers to get the thickness and rigidity needed. Plain transparent or masking tape is fine.

We generally use on one of the new self-healing 11 x 17 inch cutting mats. It gives an excellent surface to cut on and the self-healing feature leaves a smooth surface after a cut is made. It’s also large enough to hold the model and its parts between building sessions. For models with small parts, tape a plastic bag to the end of your cutting board. Put ALL of the cutting scraps into this bag. If you accidentally should “throw away” a small part, just dig it out of the bag.

Model Knives

Use a model knife, even a small disposable type, with a triangular blade for cutting out slots and the parts. Or, a sharp single-edge razor blade will do. We find that the modeler’s version of the surgeon’s scalpel is an excellent tool. The thin, replaceable, blades give minimum edge distortion when cutting out paper parts. For easy building, please follow our instructions: Cut slots, score on the dashed lines, then cut out the parts. Model Knives.

Special Scissors

Small curved-blade scissors make it easy to cut curves, like wing tips. Here’s how to minimize distortion when cutting out parts. Cut along a part’s straight lines with your knife and a straight-edge guide. Then, with the scissors, make a rough cut about 1/8th inch larger than the curved portion. Trim to final size with the curved scissors.

Cutting A Straight Line

A metal straight edge as a cutting guide makes it easy to trim parts to shape. One of the center-handle metal straight edges, with one side beveled, makes it easy to align along the cutting line. If the straight-edge tends to slide when cutting out heavy-weight card stock, try putting a light coat of regular rubber cement on the bottom. When dry, this gives a non-skid surface. Or, even a couple of strips of paper masking tape will work.

Folding The Parts

One can just bend the parts on the dashed lines, but accurate assembly may suffer. It’s best to score along each dashed line. For many paper models, scoring on the printed surface can give flakeing of the model’s printed lines. Score along the fold line on the BACK side of the part, prior to cutting it out. An easy way to transfer the line location is to make a pin hole at each end of the line just slightly past the part’s outline. Turn the part

over, and score between the pin pricks. Use care, especially with laser-printed parts, as the “color” tends to chip easily.

HINT! An *empty* ball-point pen will still have a bit of ink. Some ink may come out from the heat of your hand. To be sure the pen is completely dry, close the air-vent hole with a drop of cement (the plastic “pencil-type” pens usually have the vent hole at the top end or under the eraser). If in doubt, make a pin hole at the end of each dashed line. Then, score on the back side of the part.

Coloring Cut -Paper Edges

For a more realistic model, color the cut edges of all parts **before** assembly. Use a colored marker pen or pencil around the edges. Make sure you test a marker pen on a scrap piece of paper from your model first. Some markers can “bleed” into the paper fibers, ruining the part’s finish.

Glues & Cement

The so-called “Craft” glue is a thick type of water-based “white” glue. It dries clear. You can also use a very light coat of water-based “White” glue, like Elmers® brand, for assembly. Put some of this thin glue in a plastic lid, like one from a coffee can. Let the white glue dry a bit so that it become “tacky.” Apply to parts with a toothpick. Immediately wipe off any excess with a damp paper towel.

Or, you might wish to try a model-type cement. We find that the Duco® brand of household cement works fine. It dries fast, but still has a reasonable working time letting you slide parts into final position. For any glue or cement, use small amounts to avoid warping the paper.

If your printing and “colored ink” are waterproof, like from an Laser printer, use thick craft-type “white” glue for assembly — remove any that squeezes out from the joints with a damp paper towel or cotton swab. If you can’t find the thick “craft-type” white glue, just squirt some of the regular stuff into a plastic coffee-can lid and let it thicken a bit. Apply with a toothpick. Do make sure that you test fit all parts before assembly. A bit of error in cutting on the line, inside or outside the line, can make a big difference.

If your model’s colors and printing aren’t waterproof, as with most Ink-Jet printers, we find that the Duco Brand of Household Cement — it’s much like model-airplane glue — works very well. It’s a bit thinner than regular model cement, giving a bit of “working” time to slide the parts into final position. The solvent in “Duco” DISSOLVES laser-printed images, so if you printed with a laser, use care! **DO NOT USE THE “INSTANT” or so-called CRAZY GLUES!!**

Tools

And excellent source of small tools for modelers is:

Micro Mark
340 Snyder Avenue
Berkeley Heights, NJ 07922-1595
Send \$1 For Color-Illustrated Catalog.
1 (800) 225-1066

Printing Problems

The Adobe Acrobat™ system of readers supports IBM-PC type computers running DOS and Windows. FREE readers are also available for the Apple Macintosh and Sun “SPARC” Workstations running under the Unix operating system. If your software source does not have the correct reader for your system, they can be obtained via Internet from: <ftp.adobe.com>

Printing is supported for raster-type printers, like an HP LaserJet, and Postscript printers. Printing may be done in either monochrome or color, depending on the printer you have available. Please note that some of the Adobe Readers, like Version 1.0 for DOS, may not support color printing, or only support color printers in the monochrome print mode.

When printing to any inkjet printer, make sure you use a print buffer so the printer receives a constant stream of data. This prevents minor gaps and blurs if the printer has to wait for more data. This is particularly important for color inkjet printers.

For Windows printing, make sure to use the Print Manager for print buffering. If you have difficulty printing under Windows, make sure that you have sufficient free disk space for the buffer files created by the Windows Print Manager. As an example, each printed color page requires about 500-kbytes of disk space — during image processing, the disk requirements can be greater than 4 Mbytes for temporary files.

Not Enough Disk Space

In extreme cases, not enough disk space shows as either a terminated print — the program appears to print, but nothing happens — or error messages like “Insufficient Memory” or “Not Enough Memory To Print.” Some versions of Adobe Acrobat can give a General Protection Fault in “module unknown” and terminate while attempting to print. Free up space on your hard drive by deleting unused files or programs.

Or, try printing a single page at a time. Remember, processing color images takes a great deal of disk space for the temporary files. You may need to have 10-12 Mbytes of free disk space for the temporary files and the Print-Manager’s, or print buffer’s, image files for a non-Postscript printer.

Extremely “Thin” Lines

The illustrations are drawn with “thin” lines to fit a wide range of printers. The Adobe Acrobat print routines set these thin, or hairlines, to the precision of the printer you use. Lines printed on a 300-dpi laser printer will be one “dot” wide. Printing the same image on a 600-dpi printer may give extremely thin lines; 1/600th of an inch wide. If you use a high-resolution printer, try setting your printer to a lower resolution — this automatically widens the thin lines.

[Click Here To Return](#)

THIS IS AN UNRETOUCHED PHOTOGRAPH OF THE MODELS IN THIS BOOK

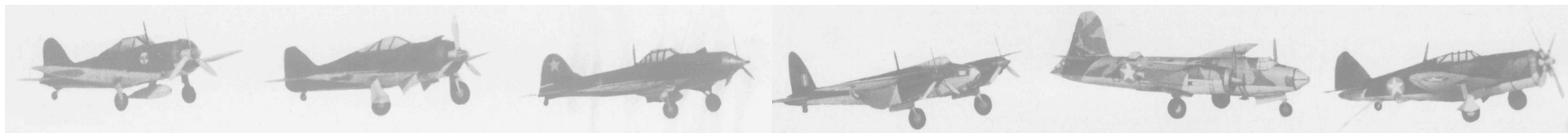

ZERO
JAPAN

FW 190
GERMANY

STORMOVIK
RUSSIA

MOSQUITO
BRITAIN

MARAUDER
U. S. A.

THUNDERBOLT
U. S. A.

EASY TO BUILD MODELS OF WARPLANES OF THE WORLD — 2nd Series

TABLE OF CONTENTS

General Building and Flying Hints and Instructions for All Models	2	Focke-Wulf 190 (Germany)	14-15	U.S Troop Glider	21
Thunderbolt Fighter (U.S.A.)	3-4	Zero Fighter (Japan)	16-17	Lancaster (British Heavy Bomber)	22-23
Marauder (Martin B-26)	5-8	TB-6B (Russian Bomber)	18	Hurricane (British Fighter)	24
DeHavilland Mosquito Bomber (R.A.F.)	9-11	M.E. 109 (Germany)	18	Corsair (Navy Fighter)	25
Stormovik (Russia)	12-13	Lightning (P38)	18	Apache (North American Fighter)	26
		Curtiss Commando	19-20	Macchi C 202 (Italian Fighter)	27

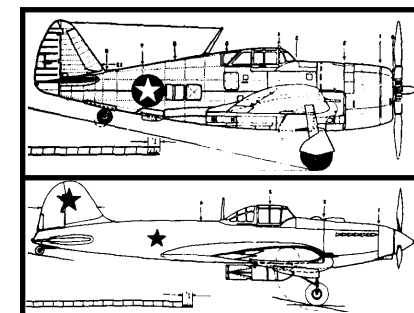

THUNDERBOLT and STORMOVIK as they appear in official plans. compare with models in the photograph above.

SOME NOTES BY THE DESIGNER

The models in this book comprise a range of the very latest and best-known aircraft in the active service of the United Nations and their enemies. Prototypes, like Thunderbolt and the R.A.F. Mosquito, are rapidly becoming famous, and are making their sting felt wherever they are being employed against the common enemy.

Paper, or thin cardboard, has no equal as a material for the easy, rigid assembly of near-scale models of almost anything, and I have made a very intensive study of how to best fold and crease in order to get the utmost rigidity with maximum realism. All the models are simply to build, but this does not mean that some care should not be taken to see that instructions are carried out and a certain amount of patience expended to achieve the really startling realism which has been embodied in all the models.

The book is divided into two sections. The first, a section on thick, specially chosen paper, and dealing with six colored versions of the most up-to-date Service Airplanes, accurate enough to make them usable for identification purposes, and to serve as decorative models. The second, on a special thin, tough paper, is devoted to near-scale replicas or adaptations equally well-known airplanes, but all made to glide if reasonably well put together. It will be fascinating to compare the swift steady glide of the fighters to the markedly slower flight of the troop-glider. Make these flying models slowly and carefully, gluing parts together firmly, and you will have many hours of most instructive enjoyment and be all the wiser in the matter of aerodynamics.

Start to build only if you really feel like it, and put a model aside to be finished if you grow tired. In this way you will do full justice to your work. Make trial assemblies before gluing-up. Above all, read the instructions and ask advice if there is something which you cannot quite make out.

Work with clean fingers, keep a duster handy and a bowl of water (away from your elbow!) in which to wash glue off your fingers from time to time. Have the following utensils handy if possible: small scissors, a penknife, a ruler, a sharp point, such as a hard pencil, or a steel knitting needle to crease the dotted lines with, some assorted elastic bands with which to hold shaped-up parts such as fuselage, some paper clips both to hold parts together and to use as weights in the gliding section. A roll of Scotch tape may be useful to reunite split parts if you have accidents. Finally, get a few toothpicks, or other fine wood spars to use for reinforcing the models here and there, especially the flyers. Use good quality tube glue. See that it is running thinly, and spread preferably with a paintbrush. Do not allow tabs to stand before inserting into slits in case the glue dries rapidly and causes the tab to curl.

I repeat as a final caution, "follow the instructions" on page 2, as well as the special notes which appear with the models themselves and **MAKE TRIAL ASSEMBLIES BEFORE FINALLY GLUING DOWN.**

You will be delighted with the result and will be well rewarded in hours of fun for the time you have spent in this interesting and instructive hobby.

**THESE
MODELS
ARE
REAL
ENGINEERING
JOBS
NOT JUST
CARDBOARD
CUTOUTS**

READ AND RE-READ THESE INSTRUCTIONS — CONSULT THESE DIAGRAMS

SCALE MODELS. Throughout the book the general assembly is standard for all models. The simple basis is that of sharp folds at suitable areas and joints closed by the use of tabs fixed into slits. All slits and tabs have been similarly numbered; thus, tab 23 goes in slit 23. In this color section all cutting, creasing, and piercing of slits have been done for you. All we ask is that you detach parts most carefully, using the point of a Knife or small scissors if a part will not come away by itself. Next, pass a Knife point through slits which may be tight so that tabs will not tend to curl. Finally, never force a tab into a slit. If it does not go easily, use your knife point to slightly widen the slit.

Most troubles can be avoided by always making a trial assembly before gluing,

HERE IS A VERY IMPORTANT HINT. Same of the parts are of a size and so closely perforated with slits that they may tend to crack while being warped into a rounded shape. Therefore, **NEVER BEND ANY PART WITH VIOLENCE.** Try it slowly, and if it does not give or shows signs of developing unsightly wrinkles, wet the part on the back then slowly round it, preferably using a round pencil on which to "form" the curve.

To make double-surface wings neatly, glue the closing flaps down while the wing is held flat on the table (by the way, have a sheet of cardboard to work on if the table is Polished. Wings will look excellent if their tips are very thinly glued at the point shown in the Diagram and if small pads of common wool or tissue are carefully pushed down, one at the extreme tip and the other at about the middle. After the two wings have been attached to the fuselage, it is a good idea to turn the model over so that the wings will have a chance to set at the desired upward tilt. This is illustrated in the diagram.

Fuselages may be filled with tissue during their assembly to add more rigidity, but care should be taken not to let the tissue fill the area behind the slits so that wing and tail tabs cannot be inserted.

Reinforce landing-gear legs with toothpicks. Glue wheels to a piece of thin cardboard for extra strength. Also glue propellers to cardboard to make their thin blades more durable. Any parts of all models may be further strengthened at discretion. For instance, the long noses of thin fuselages may be toughened by gluing toothpicks in the inside walls before assembling. Press flat newly glued surfaces, such as rudders, between the leaves of an old book (Sit on it while you go on working!) so that such parts may dry out fit without warps.

Finally, and once more, **MAKE TRIAL ASSEMBLIES BEFORE GLUING** and **EASE OPEN ANY TIGHT SLITS.**

FLYING MODELS. Designed for extreme lightness, on special thin, tough paper, these models will glide with utmost buoyancy if well built, and are real object lessons in paper glider construction and aerodynamic soundness.

MAKE UP YOUR MIND TO PREPARE THE PARTS OF THESE MODELS WITH THE GREATEST CARE AND PATIENCE. Do not be dismayed of the apparently weak character of parts as they seem when cut out by themselves and unassembled. By the time all these thin parts have been folded and locked, one into the other, the combined strength in the finished model will surprise you.

Study all parts carefully before cutting out. Note the position of all cuts and creases to be made and make them while the model is still in the sheet form. Cuts are always shown as double lines (slits) and folding lines as creases. **DO NOT CREASE THESE DOTTED LINES TOO DEEPLY**, otherwise the part may split.

It is a good idea to reinforce the noses of all models, from within, by gluing toothpicks to the inside walls, one each side, one on the bottom, and one on the roof of the nose (inside).

Do not reinforce anywhere else, except to strengthen legs of landing gear if models are to be used as ornaments.

Assemble all parts patiently, using very little glue to seal tabs in slits. Use a small paintbrush for spreading a thin glue coat and always fix the parts at once, seeing that they stay accurately in position while the glue is setting. In the case of a fuselage, like that of the Commando, see that the nose and tail are fixed upright at the joint and not allowed to drop left or right, up or down. Tails are passed into tail slits by bending one of the elevators right back and then unbending when the tail has gone through.

Attach wings strongly and always with an upward tilt. See that the fin is upright and the tail level.

The glide of the model will depend upon the weight in the nose. A weight has been specified for each model, one or two paper clips, either attached to front of nose or wrapped inside in a piece of tissue and glued to prevent movement in the nose. **Make trial weight tests to arrive at a good balance, preferably taking the model outdoors. SLIGHT EXCESS WEIGHT IS PREFERABLE TO NOSE-LIGHTNESS.**

TRY EACH PART FOR FIT BEFORE GLUING

SOME SPECIAL HINTS. We have said that the building of these models is an engineering job. An engineer needs tools, but it is possible to assemble these models with the aid of a small knife, a ruler and a small watercolor brush to spread glue on. However, the following items will be useful to have at your elbow. Some elastic bands to pass over fuselage when standing to dry, or a reel of thread if bands are not available. Use paper clips to hold rudder sides when gluing, but do not press them too far on the part, and then press, as the clip may leave deep marks and spoil the appearance. Small strips of cellophane tape can often be used in addition to gluing, but it should not be used on the outside of parts, unless you wish to make the cabin windows shine by cutting a cellophane tape cover to give a gloss effect. Use non-spirit glue from a small tube. This runs out in just the quantity you need and saves waste by drying, also you won't upset it and mess your furniture. Use small scissors for cutting out the thin flying paper models. Score or crease with a not-too-sharp point, with smooth cardboard underneath the sheet. Cut slits cleanly with a very sharp point so that the paper does not rag up. Finally, do not be afraid to trim a part if you think it will fit better. Also, if joints show white paper through slight misfit, take some watercolor and match in the missing color, taking care not to have the color too moist to cause the paper to distort.

In those models where a rounded back and a rounded underside are featured, and especially where the joint takes place right in the middle of the curve, be sure to knead and work the areas to be rounded off into the necessary curved shape before joining up. In this way the edges will come together in a steady curve without being spoiled by the glued joint. This rounding off can be done by gently rolling over a pencil or other rounded shaft or by wetting very slightly. **THROUGH-OUT THE BOOK ALL PARTS HAVE BEEN SO PLACED IN THE PAGES THAT ALL WILL ROLL EASILY WITHOUT A TENDENCY TO CRACK BUT SHOULD STILL BE HANDLED GENTLY.**

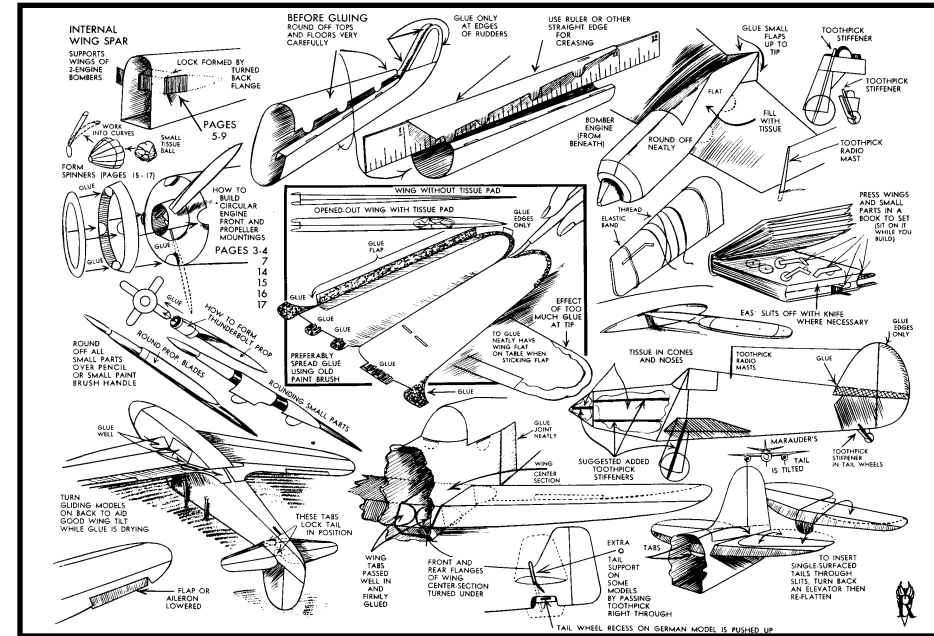

HOW TO LAUNCH THE GLIDERS

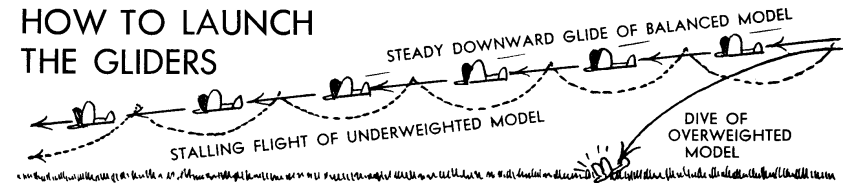

HOW TO GLIDE THE MODELS. The model should be launched nose slightly down, and a gentle shove, with a follow-through movement of the hand, should produce a level downward glide. Out in the open models will often rise and be carried surprising distances if the air is warm.

If model dives, lift elevators slightly. If it stalls, keeps on sticking its nose up, see that the tail is flat, or, if necessary, add a fraction more weight. Use rudder to correct a tendency to turn persistently in a certain direction. Elevate slightly to loop a model, and throw more sharply, slightly upward. The successful gliding of these models will be a matter for experiment, do this outside if possible, until a model has been well adjusted and can then be flown inside without fear of damaging dives.

COLORING THE MODELS. The models in this section can be colored with crayons, or watercolor. Use the least possible water. For correct schemes follow the models and their markings as in the color section. Coloring should be done while the model is still in the sheet, and allowed to dry, putting the dried-off sheet to press for a few hours, or a night, inside a book under pressure. For best flying results it is better, however, to leave the model uncolored.

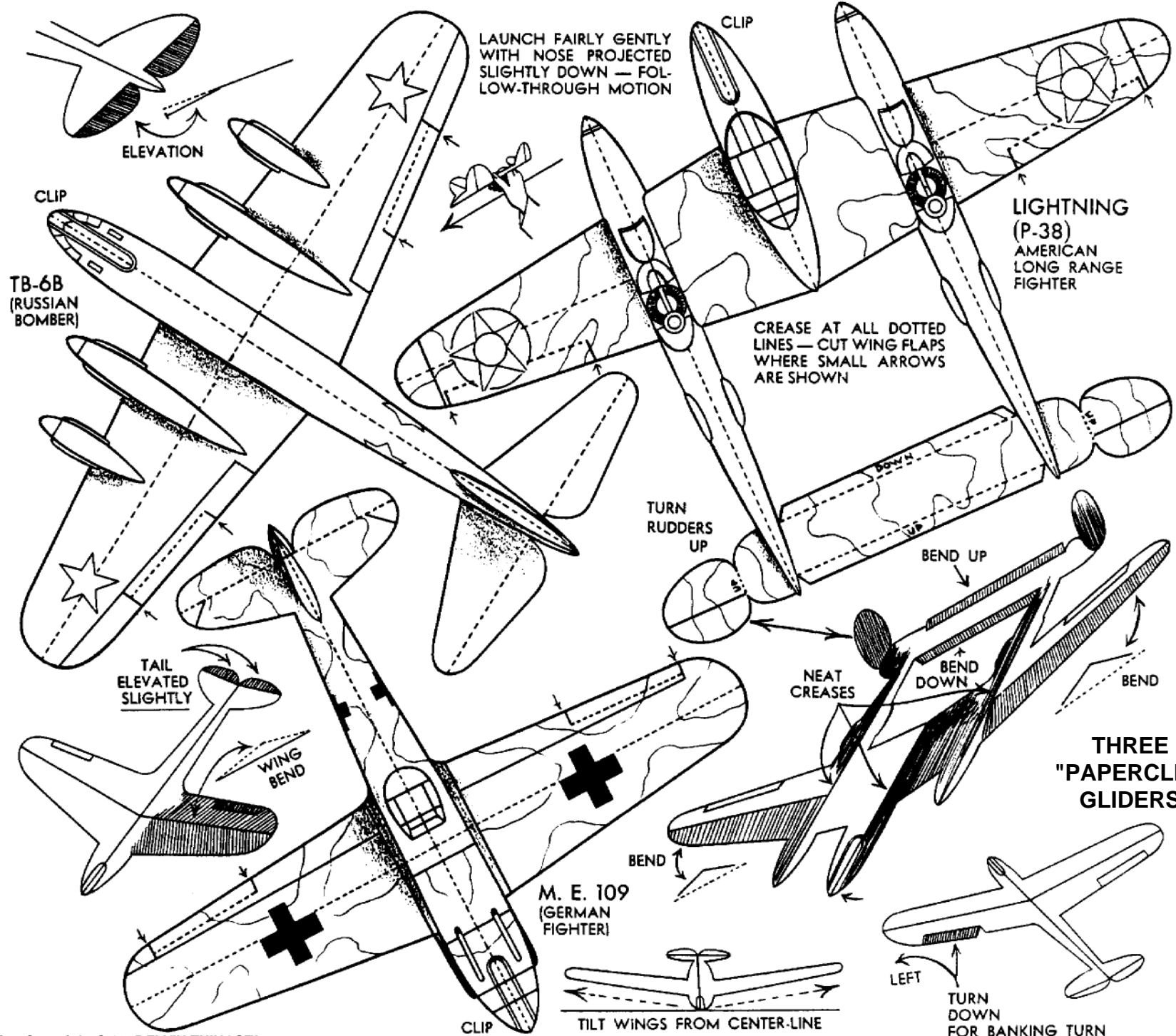

LAUNCH FAIRLY GENTLY
WITH NOSE PROJECTED
SLIGHTLY DOWN — FOL-
LOW-THROUGH MOTION

ELEVATION

TB-6B
(RUSSIAN
BOMBER)

LIGHTNING
(P-38)
AMERICAN
LONG RANGE
FIGHTER

CREASE AT ALL DOTTED
LINES — CUT WING FLAPS
WHERE SMALL ARROWS
ARE SHOWN

TURN
RUDDERS
UP

BEND UP

NEAT
CREASES

BEND
DOWN

BEND

THREE
"PAPERCLIP"
GLIDERS

TAIL
ELEVATED
SLIGHTLY

WING
BEND

M. E. 109
(GERMAN
FIGHTER)

BEND



TILT WINGS FROM CENTER-LINE

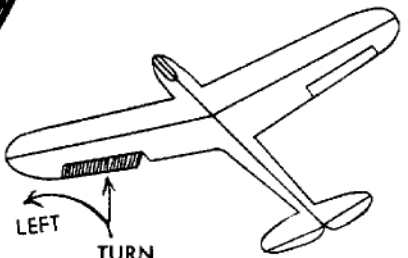

LEFT

TURN
DOWN
FOR BANKING
TURN

HURRICANE (BRITISH FIGHTER)

PART 2 (NOSE)

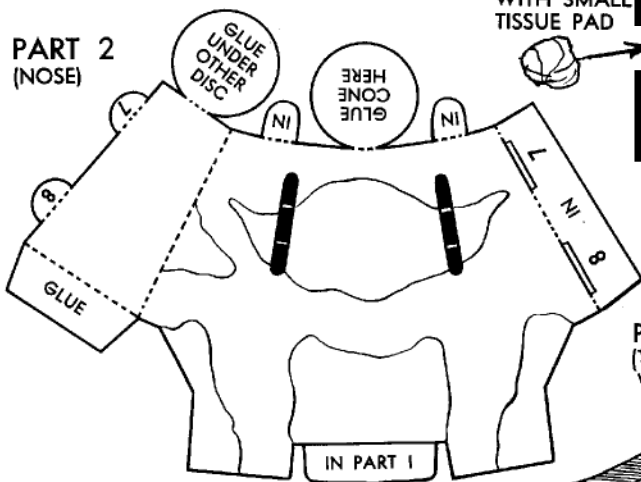

FILL CONE WITH SMALL TISSUE PAD

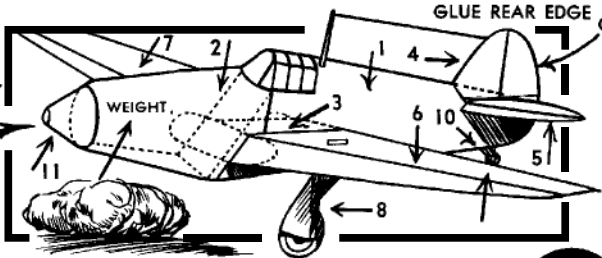

PART 3 (WING CENTER)

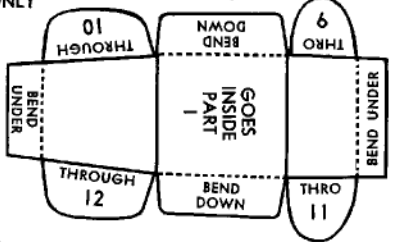

FOLD

PT. 10 (TAIL WHEEL)

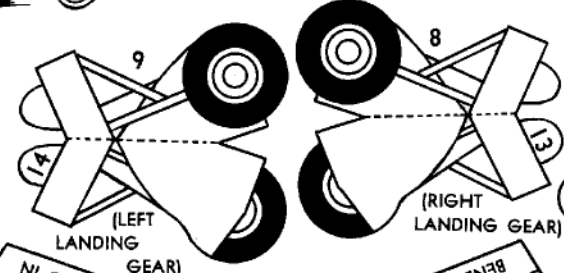

PART 7 (LEFT WING)

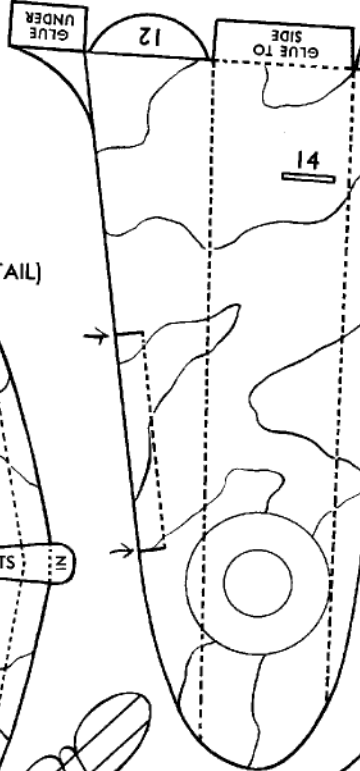

PART 5 (TAIL)

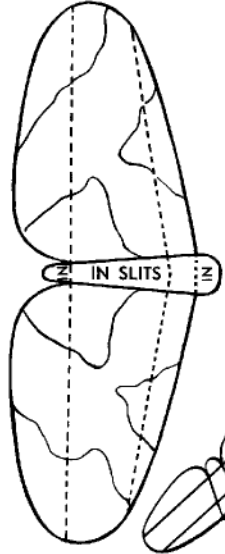

PART 1 (FUSELAGE)

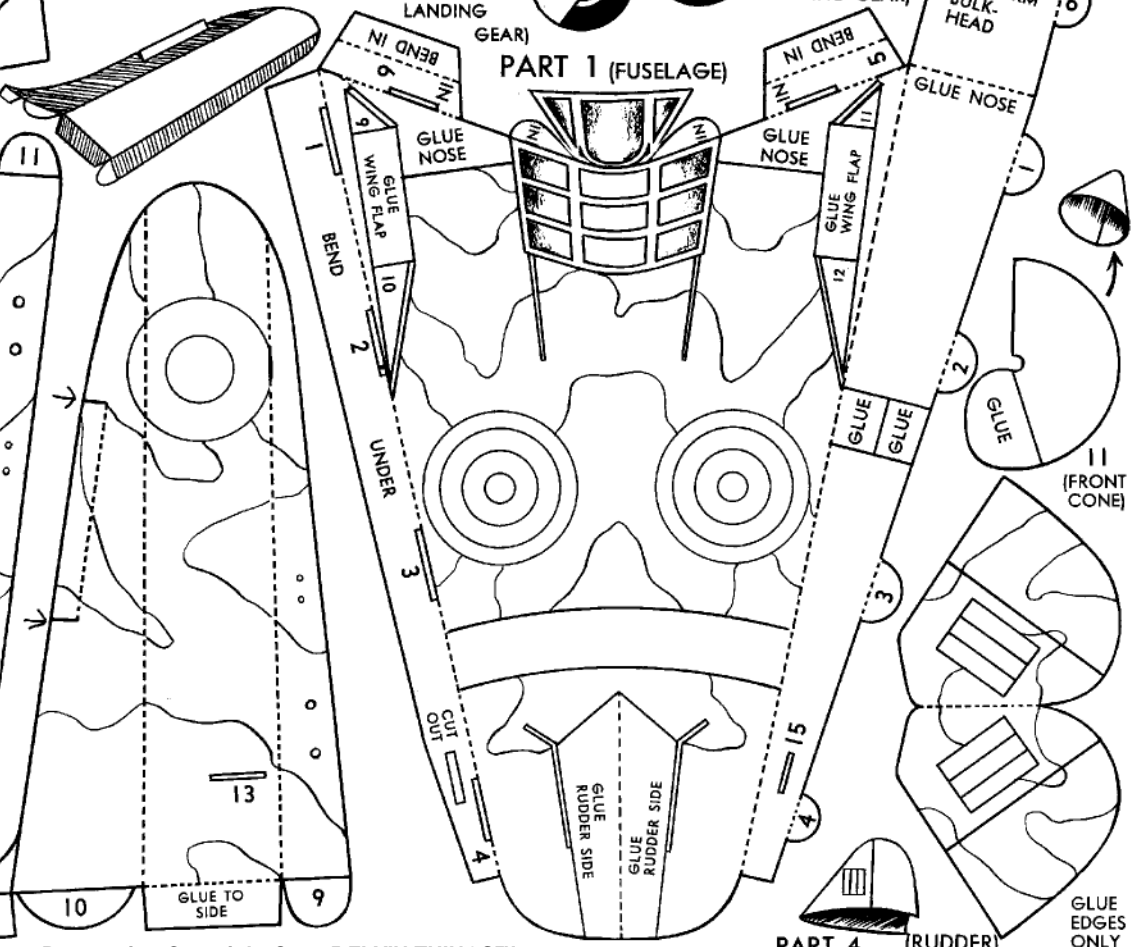

PART 6 (RIGHT WING)

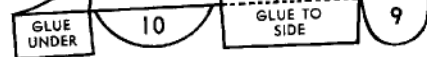

PART 4 (RUDER)

GLUE EDGES ONLY

CURTISS COMMANDO

(U. S. TRANSPORT AND CARGO)

America's hugh transport planes which carries tanks and jeeps, as well as large numbers of troops, long distances at very high speeds. Used as flying hospitals complete with full equipment for such emergencies as transfusions — thus saving many lives.

Build this models carefully and stuff nose with tissue for added strength. Attach landing gear only if not to be glided. See that a tilt to the wings is obtained for stable gliding. Use elevators on tail for any required diving or stalling tendency.

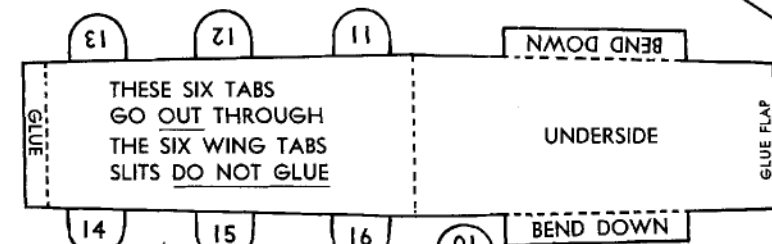
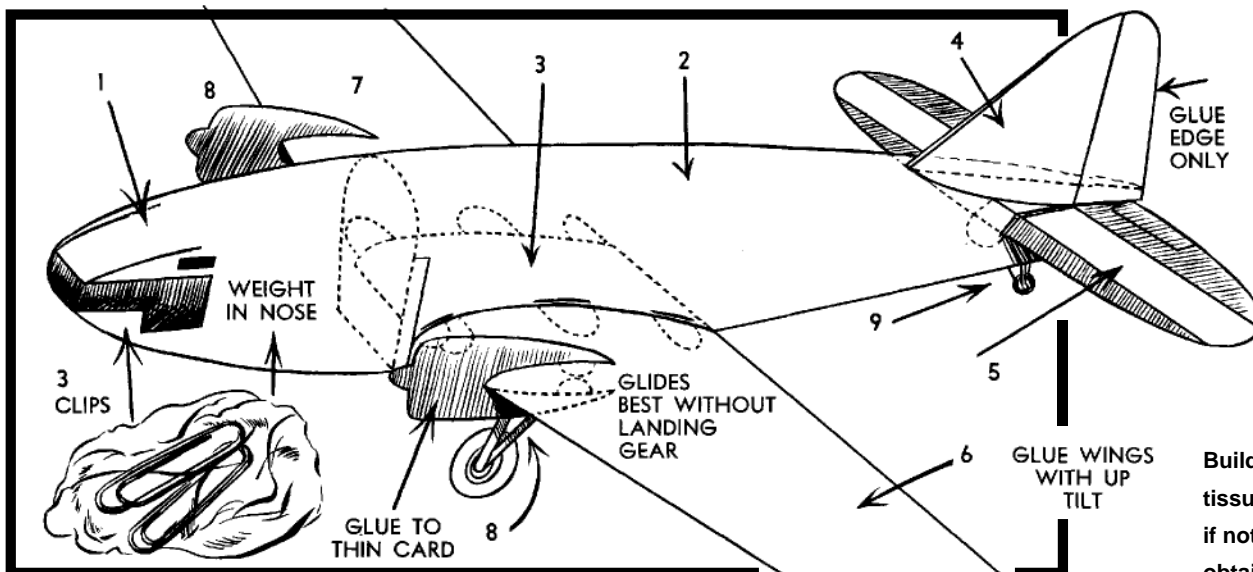

PART 5
(TAIL)

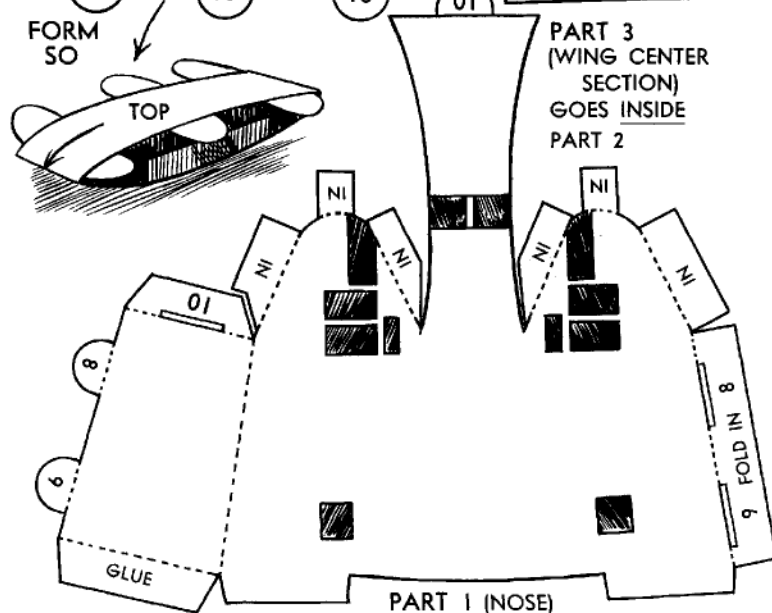

PART 1 (NOSE)

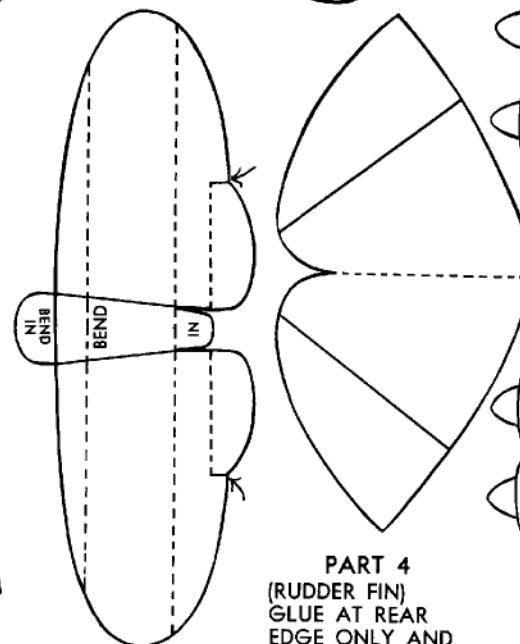

PART 4
(RUDDER FIN)
GLUE AT REAR
EDGE ONLY AND
GLUE EACH SIDE TAIL

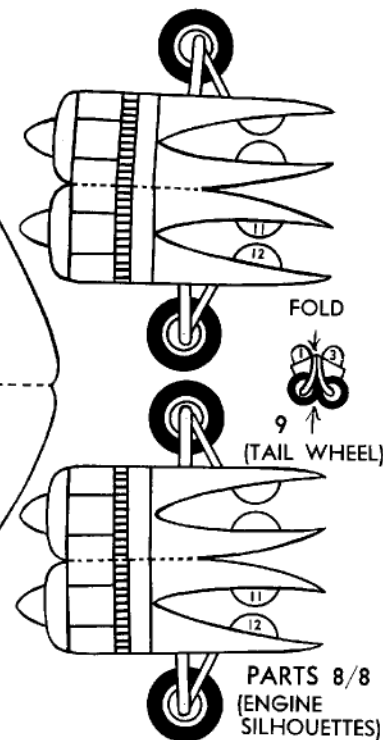

PARTS 8/8
(ENGINE
SILHOUETTES)

CURTISS COMMANDO (CONT'D)

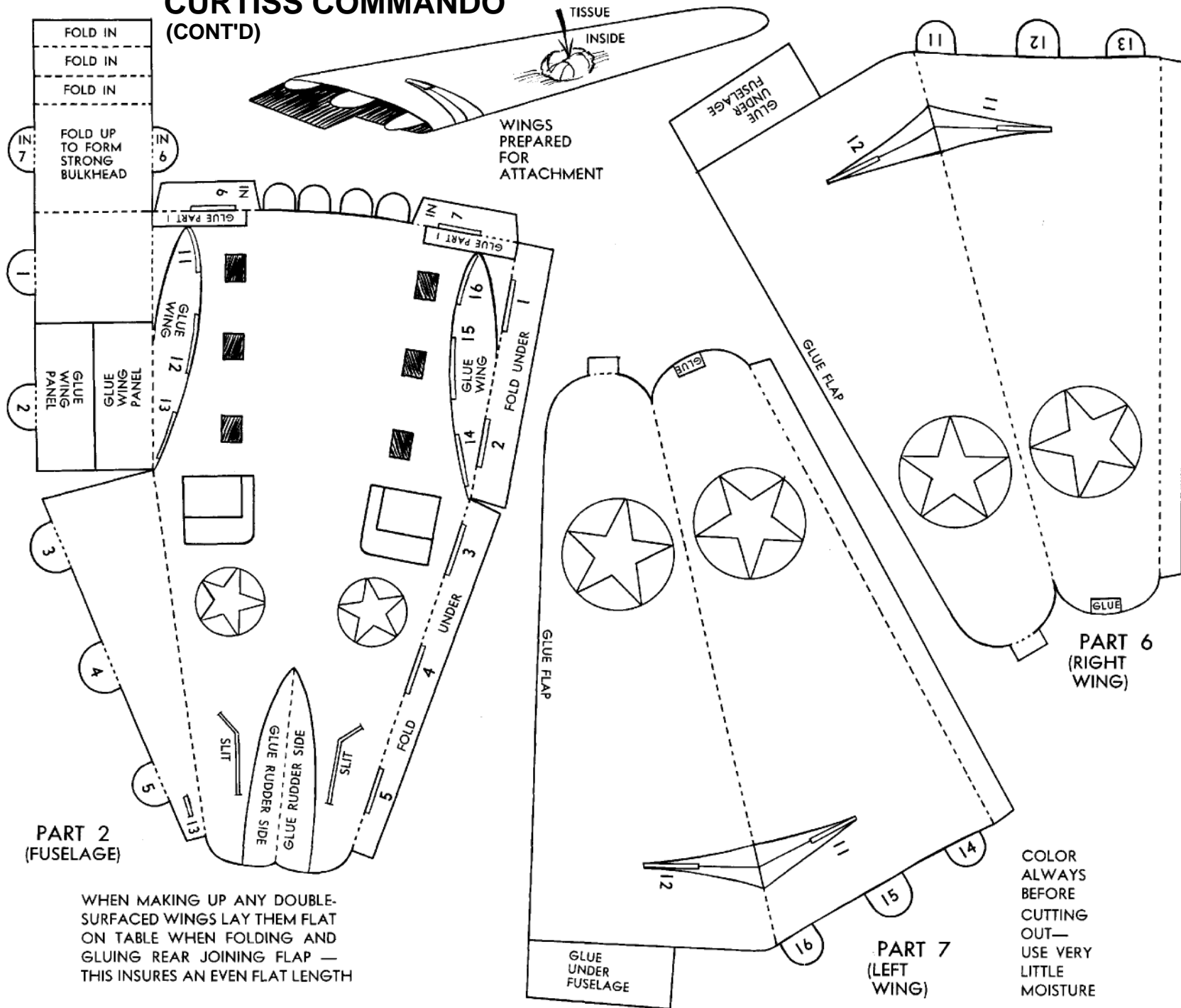

U.S. TROOP GLIDER (GLIDING ADAPTATION)

These giants, though carrying jeeps and other heavy war material, as well as troops, are most graceful gliders with simple control, and land as smoothly as their smaller companion soarers. Towed in groups by a large towing plane and released for their won landings.

Make model carefully and attach neatly and accurately. Close nose only when weight has been fully determined. This remarkable model actually glides in miniature, just like the real thing, with a glider's comparative slow speed, and will land on its undercarriage, if the wheels are working loosely in the holes.

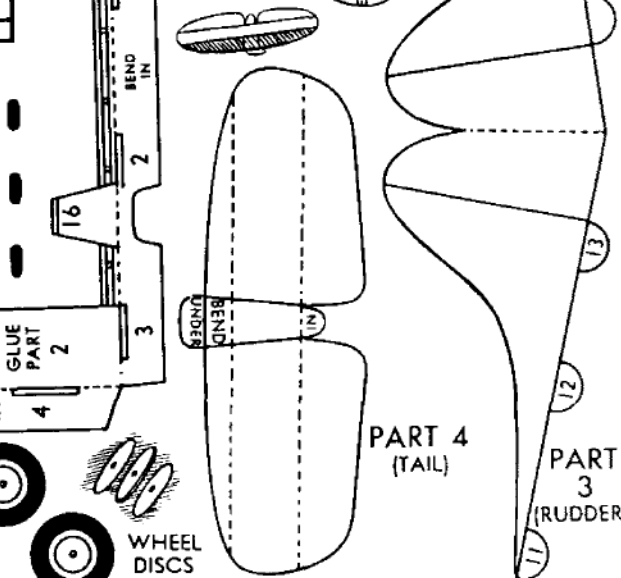
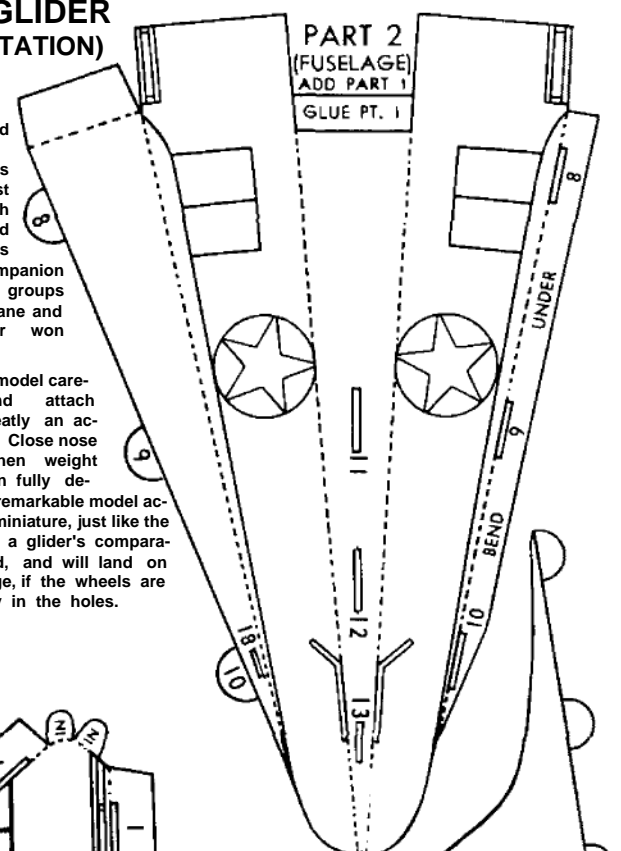
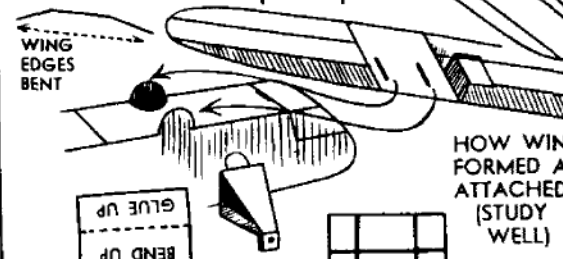
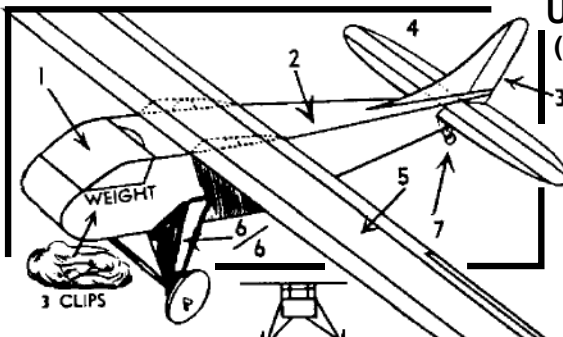

GLUE LONG FLAP OVER HERE
BEND UNDER

FRONT EDGE UNDERSIDE GLUE TO ROOF TO PASS TABS UP IN THESE SLITS FOR CENTER
BEND UP
GLUE UP

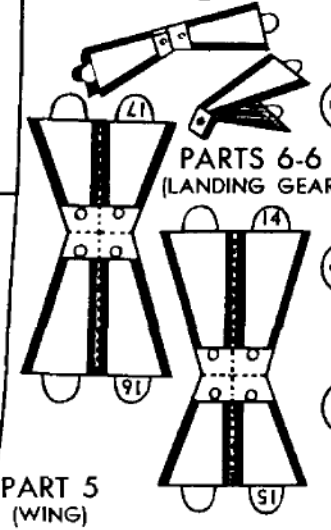

PART 5 (WING)

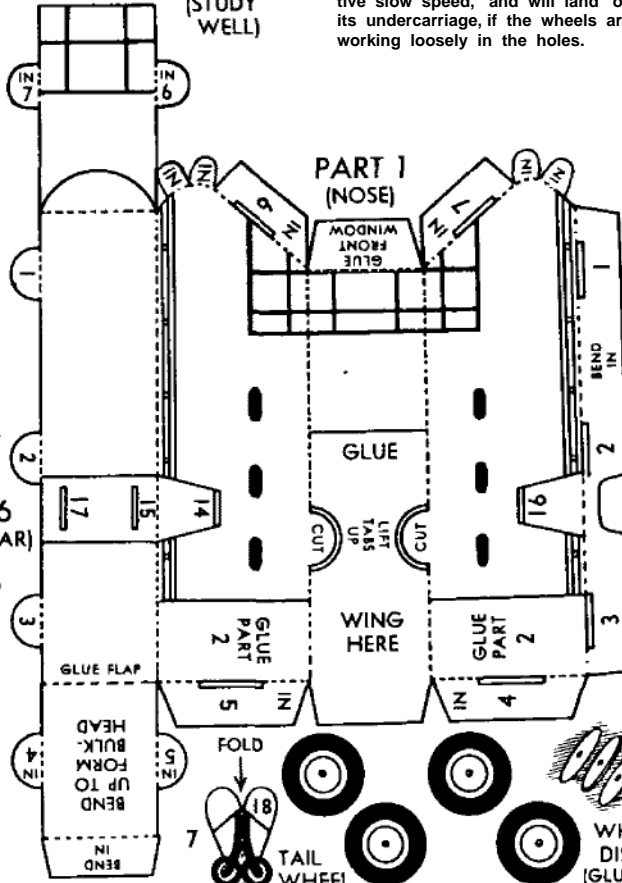

LANCASTER (BRITISH HEAVY BOMBER)

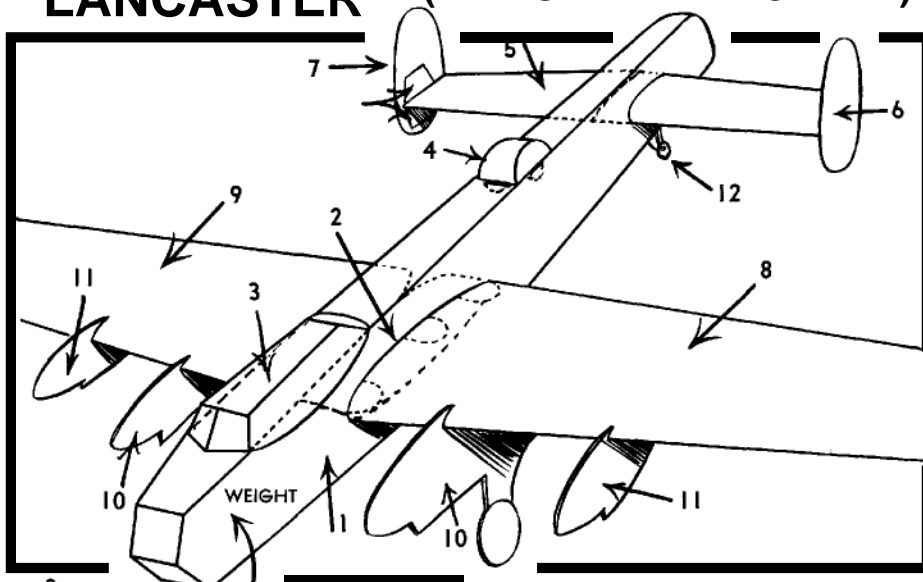

LANDING GEAR AND FOUR MOTORS SHOULD ONLY BE ATTACHED IF MODEL IS TO BE FLOWN SPARINGLY-IT GLIDES BEST WITHOUT THESE PARTS WHICH BREAK OFF QUICKLY



R. A. F. LANCASTER

The heavy bomber which delivers the blockbusters to Berlin! This machine has a long range with an enormous bomb load. Severe in line its sinister form suggests its errand—deadly destruction.

For added strength and ease of construction the model has a squared-off fuselage. Attach wings with a slight tilt and pass tail right through to a central position in the slits, then fix the twin rudders to the two pairs of tabs, which are leg upright and unglued when tail is being formed. Stuff nose with tissue and close finally only when adequate weight has been inserted (about two to three heavy Clips) The model performs best without the dummy engines and landing gear. Turn back of tail slightly up if there is a diving!

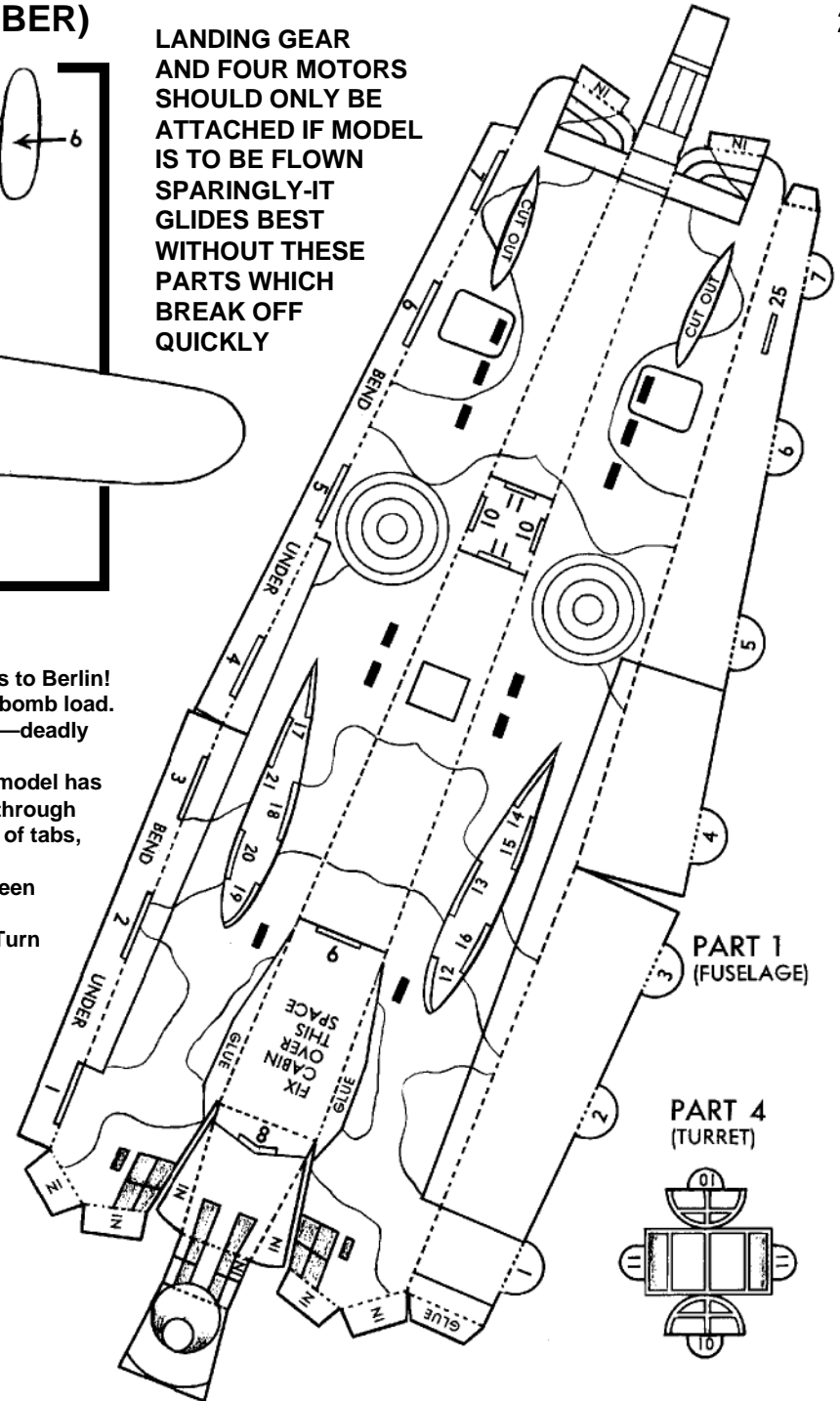
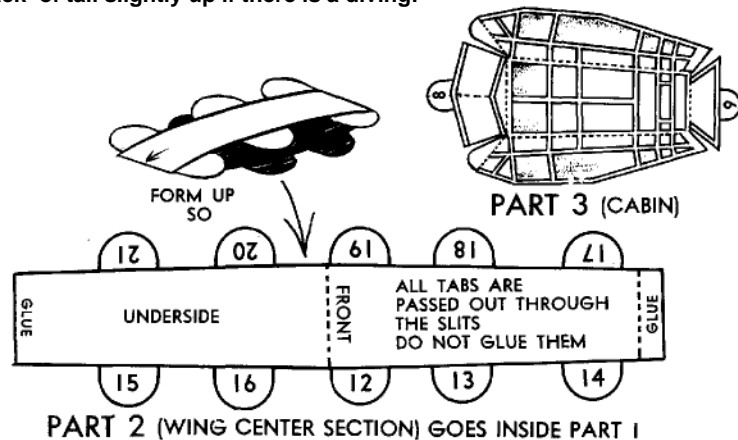

LANCASTER (CONTINUED)

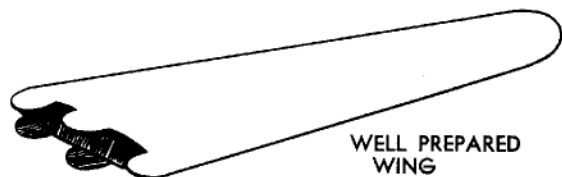

GLUE THIN CARD BETWEEN THESE PARTS

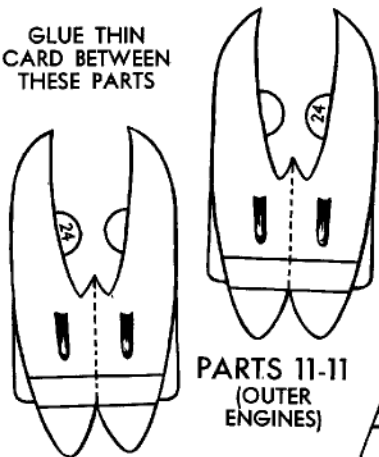

PART 5 (TAIL)

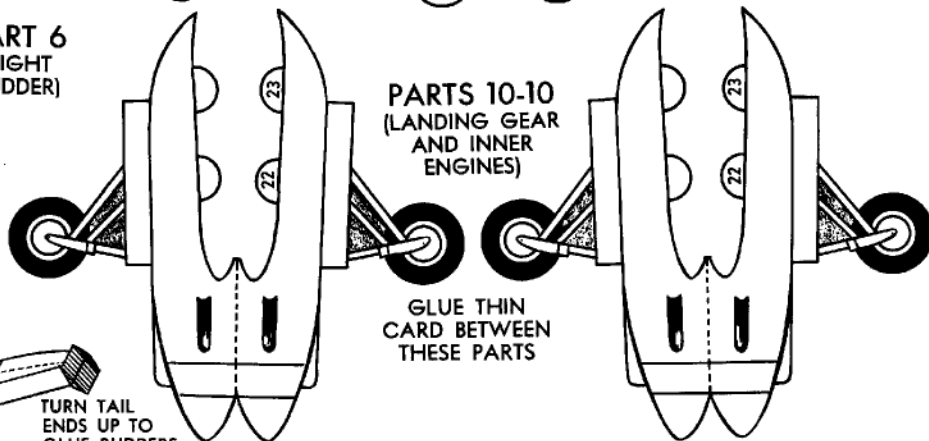
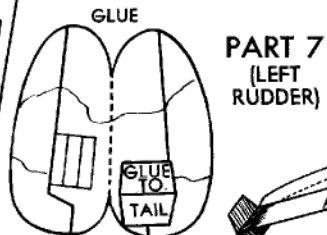
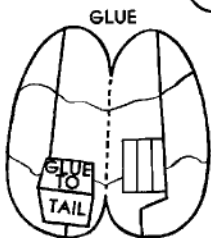
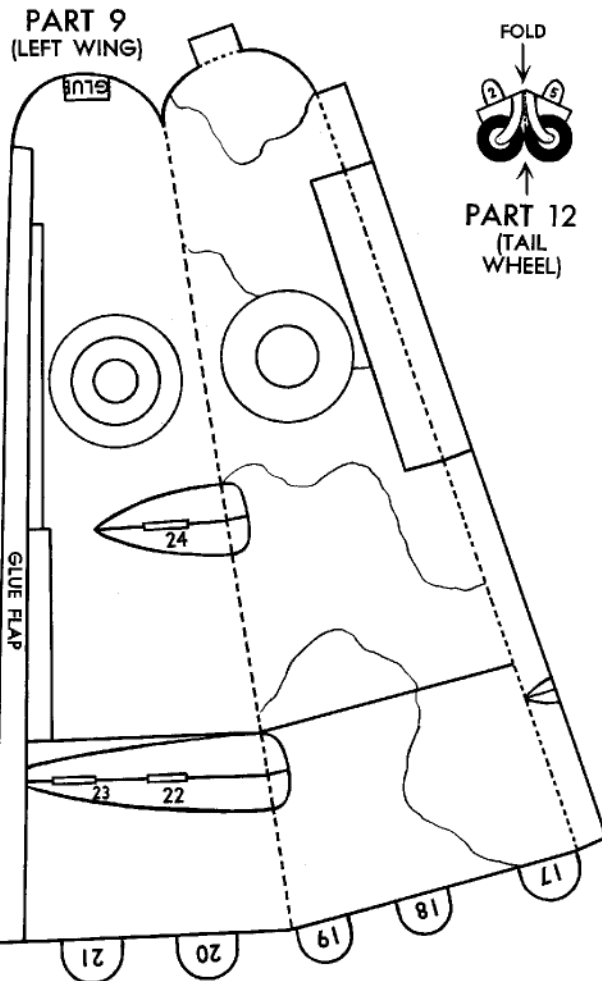
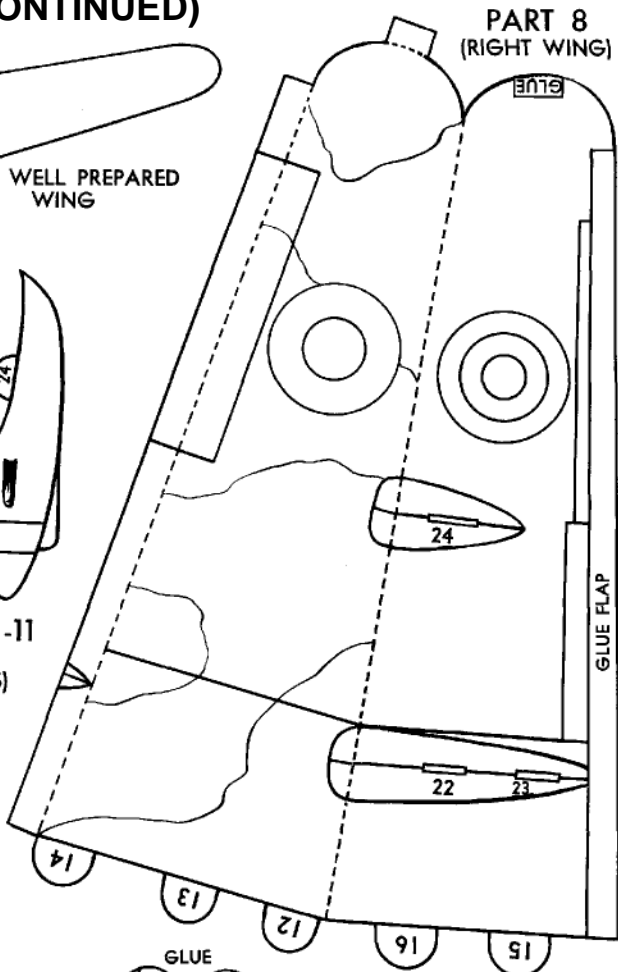
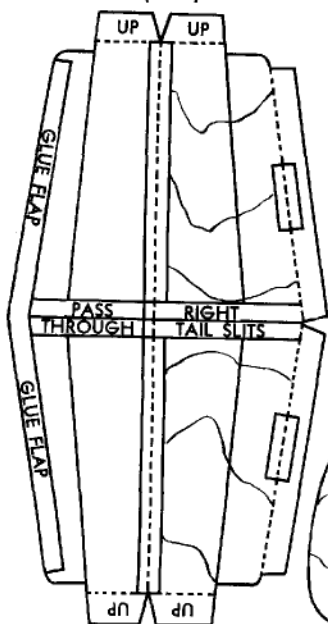

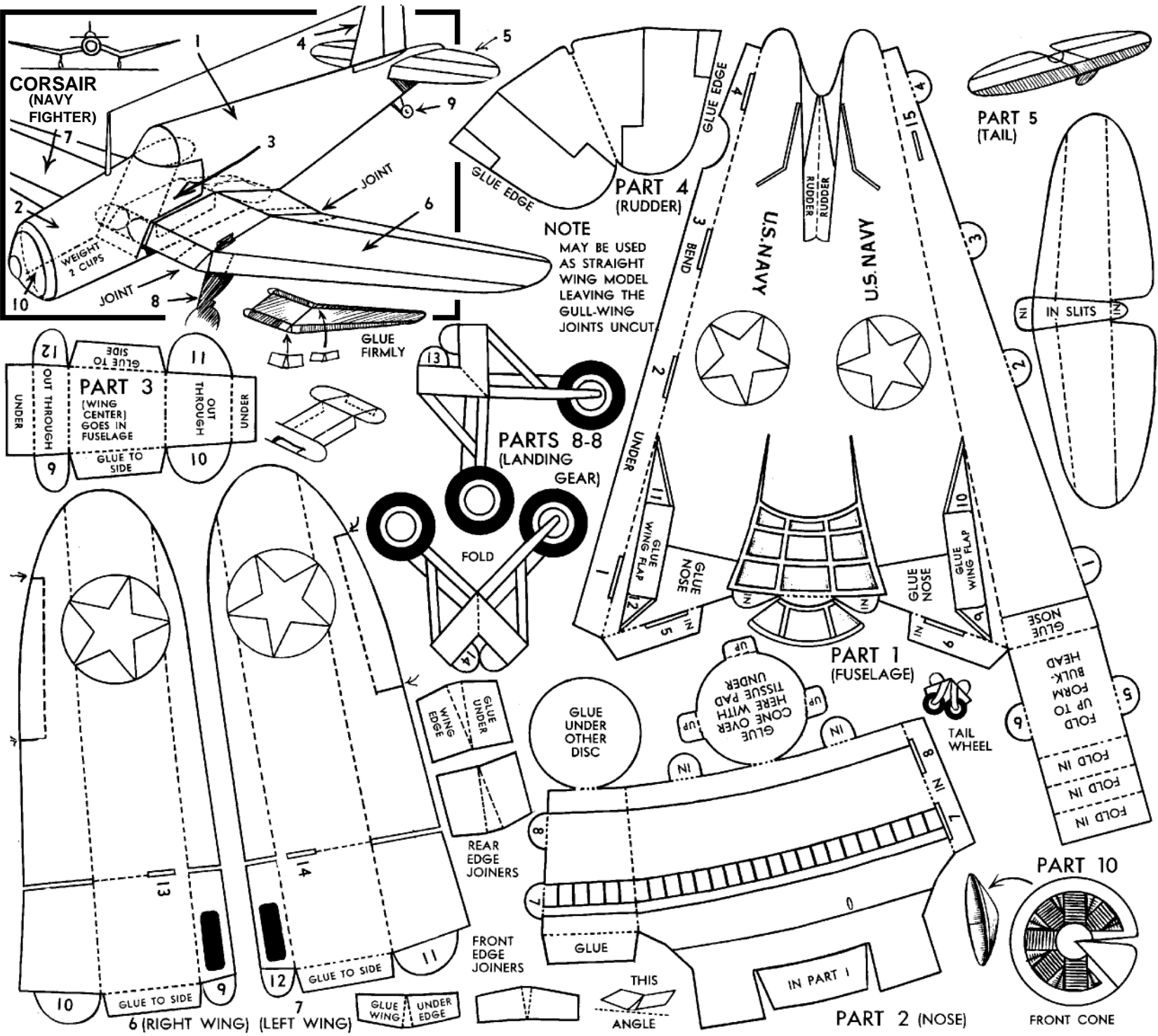

CORSAIR
(NAVY
FIGHTER)

NOTE
MAY BE USED
AS STRAIGHT
WING MODEL
LEAVING THE
GULL-WING
JOINTS UN CUT

PART 3
(WING
CENTER)
GOES IN
FUSELAGE

PARTS 8-8
(LANDING
GEAR)

PART 1
(FUSELAGE)

PART 5
(TAIL)

PART 10

PART 2 (NOSE)

Restoration Copyright © 1995 FLY'N THINGS™

APACHE (NORTH AMERICAN FIGHTERS)

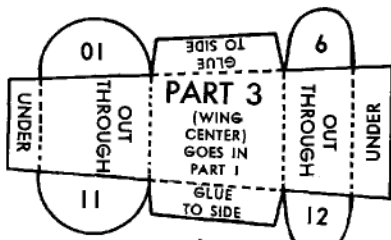
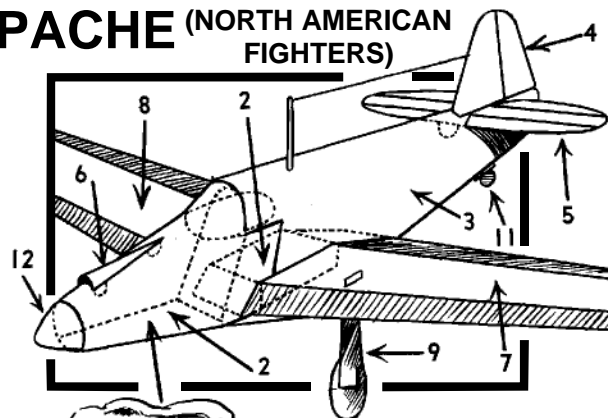

PART 1 (FUSELAGE)

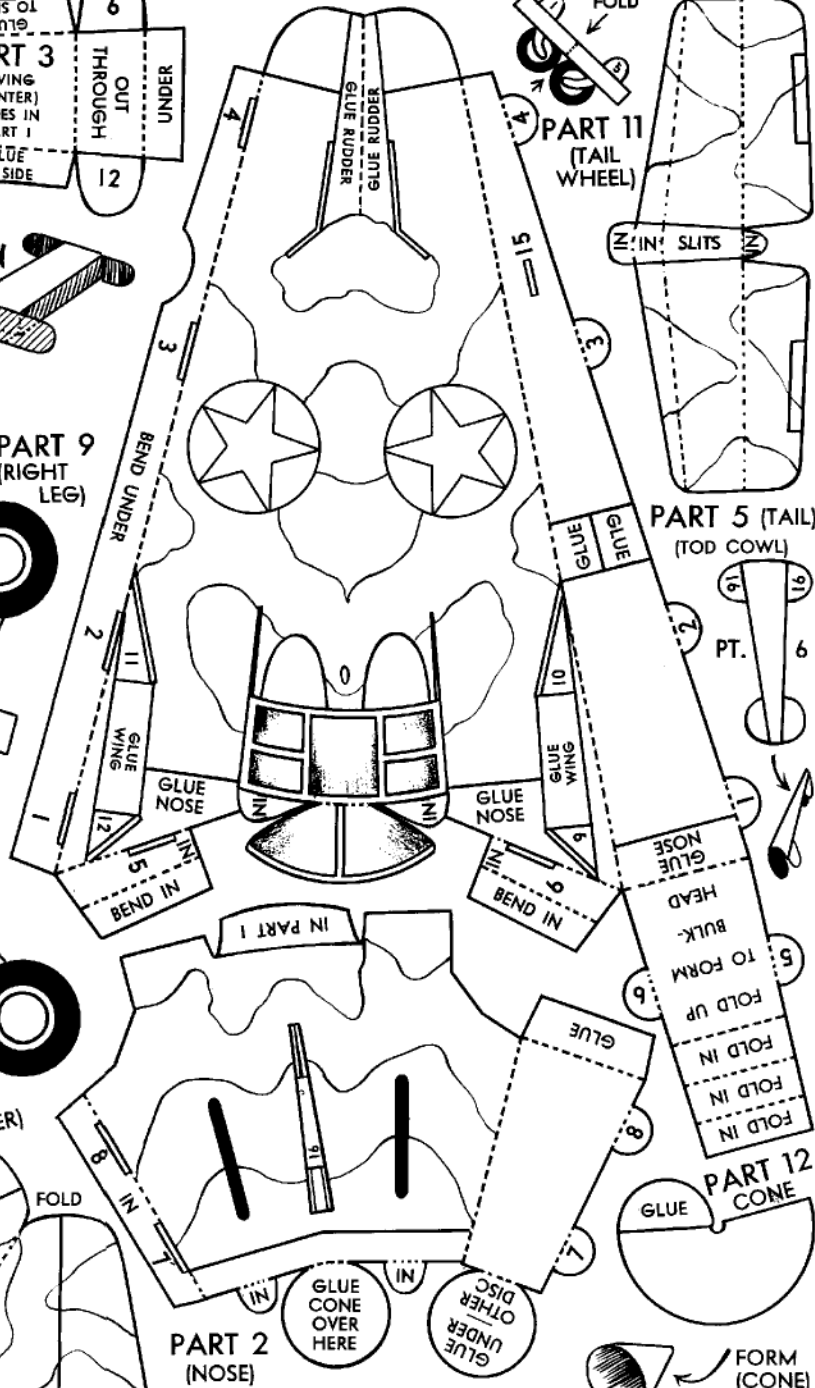

WEIGHT 2 CLIPS

A first-rate fighter of clean lines, and used very extensively by the R.A.F. (who call it MUSTANG) with whom it is exceedingly popular.
Build Model Neatly, with good wingtilt, and stuff nose with tissue.

PART 7 (RIGHT WING)

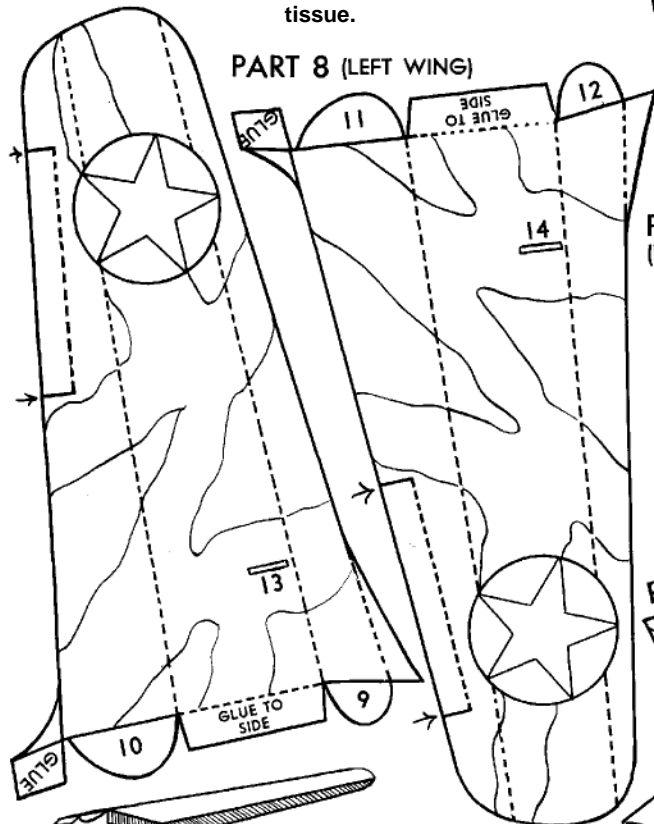

PART 8 (LEFT WING)

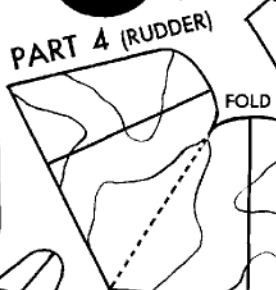
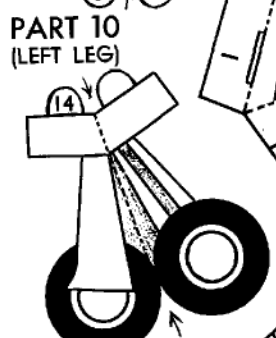
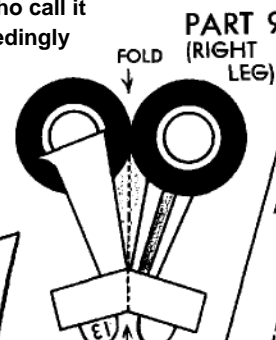
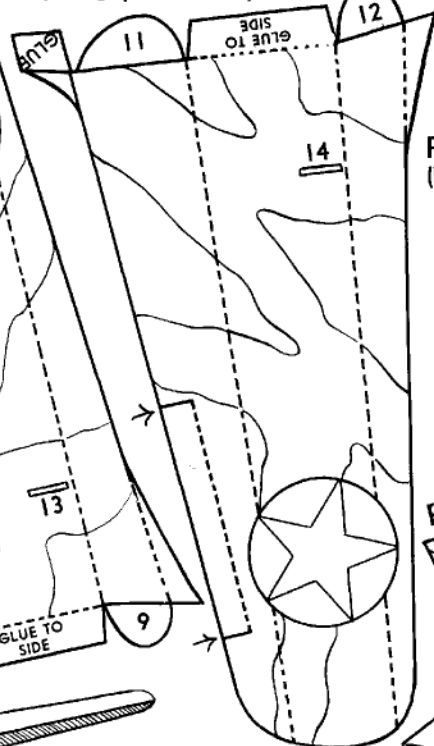

PART 2 (NOSE)

Restoration Copyright © 1995 FLY'N THINGS™

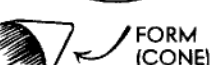

GLUE CONE OVER HERE
GLUE UNDER OTHER DISC
FORM (CONE)

MACCHI (ITALIAN FIGHTER) C 202

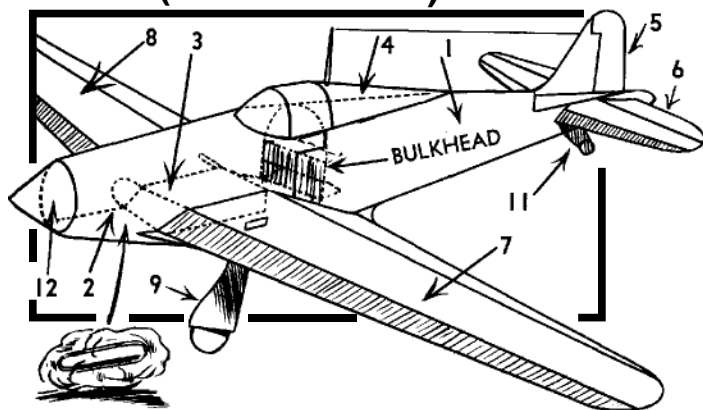

WEIGHT
2 CLIPS

PUT SMALL
TISSUE PAD
INSIDE
CONE

This fighter has clean lines and is an excellent aircraft though it does not have that "extra something" very essential to bring it into the class of Spifires and Thunderbolts. As a gliding model it will perform excellently if carefully made.

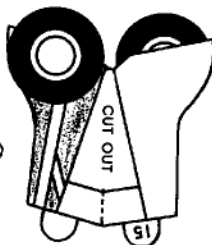

PART 9
(RIGHT LEG)

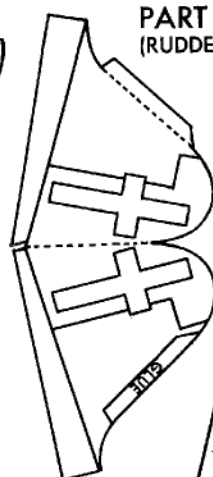

PART 5
(RUDDER)



PART 12
(CONE)

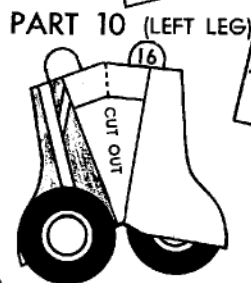

PART 10
(LEFT LEG)

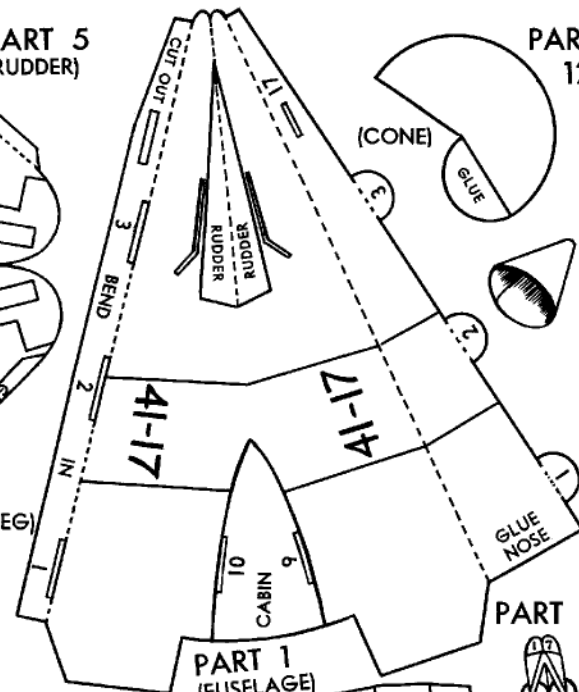

PART 11

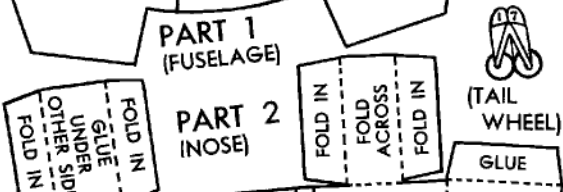

PART 1
(FUSELAGE)

PART 2
(NOSE)

(TAIL WHEEL)

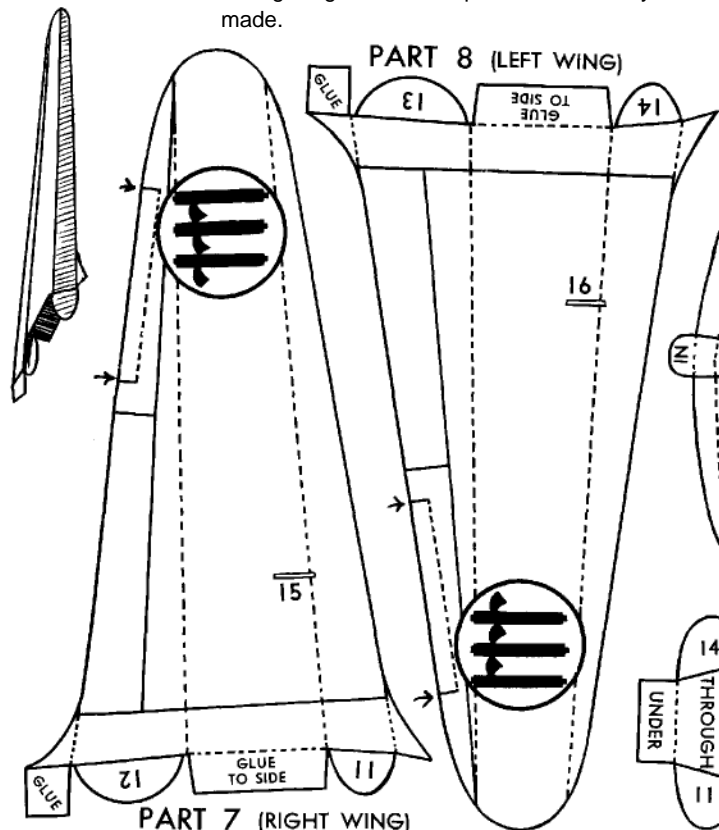

PART 7 (RIGHT WING)

PART 8 (LEFT WING)

PART 6 (TAIL)

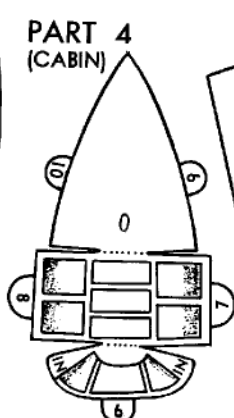
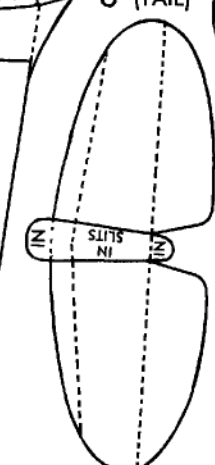

PART 4
(CABIN)

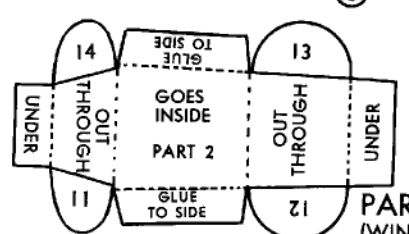

PART 3
(WING CENTER)

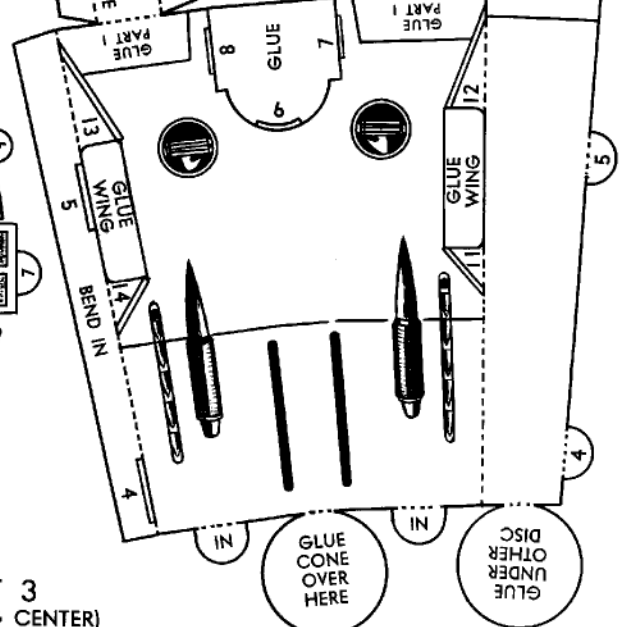

This Book Is Approved By
AIR YOUTH



A DIVISION OF THE NATIONAL AERONAUTIC ASSOCIATION

Air Youth is an organization working to further a program of aviation education for American youth and to stimulate a wider interest in aviation, among young people.

If you, like many other air-minded boys and girls who build and fly models, would like to join the Junior Air Reserve and learn more about aviation, you may write for details to:

**NATIONAL AERONAUTIC ASSOCIATION
WASHINGTON, D. C.**

RIGBY'S FAMOUS MODEL BOOKS

- Series 1 — EASY TO BUILD MODELS OF FIGHTING PLANES OF THE UNITED NATIONS.
16 fine scale models including 10 that actually fly.
- Series 2 — EASY TO BUILD MODELS OF WARPLANES OF THE WORLD.
16 fine scale models including 10 that actually fly.
- Series 3 — EASY TO BUILD MODELS OF WAR SHIPS OF THE UNITED STATES NAVY.
24 models of ships and planes of the United States Navy.



1942 Rigby Airplane Book 1
A **FLY'N THINGS™** Restoration
PKAeronaut@aol.com