

PENNY-WEIGHT FLYING PAPER AIRPLANES

Cut, Fold & Fly – WWII Pacific, Volume 2 (alternate color schemes)

Phil Koopman, Sr.

Contents:

- Introduction
- Building Instructions
- How to Fly
- P40 (US red ball; v2)
- P40 (US blue bar; v3)
- Zero (Gray; v2)
- Zero (Gray/Blue; v3)
- Zero (Vector Blue; v4)
- Zero (Blue/red; v5)
- Wildcat (Gray/yellow; v2)
- Wildcat (Gray/blue; v3)
- Val (Gray; v2)
- Hellcat (Vector 1943; v2)
- Hellcat (v3)
- Hellcat (Vector; v4)
- Dauntless (Gray, v2)
- **BONUS:** FW 190 (Vector)



Notes:

- These are alternate color schemes for some of the same designs as in volume 1. Some models are vector graphics rather than scans.
- Print models one sided, “actual size” – do not “fit to paper” or scale when printing!
- You’ll need to put a weight in the nose for level flight:
 - Recommended: if printing on 65 lb. cover stock, use a pre-1982 US penny (3.11 grams) or a 2 cent Euro coin (3.06 grams)
 - If printing on office printer paper, use a post-1982 US Penny (2.5 grams) or 1 cent Euro coin (2.3 grams)
- This is a scan of the only surviving copy of a printed draft manuscript. The original appears to have been printed on an ink jet printer, so there are various patterns in the colors associated with that process. You can touch up your plane with a felt tip marker if you like. (Typos have not been fixed.)
- I have built and flown some of these planes, but not all of them.
- I am unable to provide support, and in general not able to answer queries.
- No warranties of any kind are made. Please build and fly responsibly.
- I hope you enjoy these airplanes as much as I have!

Copyright 1993-1995 Philip Koopman Sr.

Entire contents provided for use under CC BY SA 4.0 License by Philip Koopman Jr., heir, April 4, 2020 <https://creativecommons.org/licenses/by/4.0/legalcode>





FLY'N THINGS™

Introducing The World War II Penny-Weight Flying Models

Paper models of all types are popular in many countries. This form of modeling takes many forms. Called Paper-Card Modeling in Europe, it spans the range from simple folded-paper darts, to complex three-dimensional models of airplanes, ships and buildings.

Paper models were popular in the United States during WWII. Material shortages made it difficult, if not impossible, to make models from balsa wood. Toy makers, too, were effected. With metal in short supply, many makers turned to paper substitutes. Even Lionel trains were put out as paper models in the 1940's. After WWII, paper models declined in the US. with the availability of metal and balsa wood.

The style of paper-plane construction used in this book was developed by Wallis Rigby, an Englishman. He was internationally know for his paper models of airplanes and trains. In addition to Rigby's many books of paper-model WWII airplanes, he developed models similar to those in our book as cereal premiums for General Mills. Mail in two box tops from Wheaties cereal and you received a pair of paper airplanes. In all, this type of model gave thousands of kids and adults their first try at model building.

Rigby's WWII models were simple in design and easy to build for kids of all ages. The planes were good flyers, if a bit fast, and very popular. The models were small and lacked detail. Colors were a bit on the garish side, like a blue P-40 Warhawk or a bright-yellow Nakajima fighter. Scale, too, wasn't so accurate.

We've attempted to retain the simplicity and flavor of the original models. Improvements in layouts and a larger size make the models easy to build and great flyers. And, there are new models that weren't in the Rigby series, like the Douglas Dauntless dive bomber and the US. Navy and Marines Wildcat. All models carry scale outlines and details of the real airplane. Colors, too, give an over all scale appearance. Detailed picture instructions make it easy for even young modelers to build a successful flying model.

These penny-weight planes are new models. We made the artwork with the latest in computer technology. For some of the models, custom computer programs allowed us to generate three-dimensional models from aircraft drawings. Other special programs projected these 3D images into flat surfaces used as patterns for the fuselage artwork.

The Simple Tools Needed

Most of what you'll need is already on hand -- just scissors, a single-edge razor blade and some glue will do. However, we do have some suggestions to make it easy. Please follow the step-by-step instructions. There are two basic types of construction -- airplanes with radial engines and in-line engines.

Rather than repeating dozens of steps for each model, there is a single, combined, set of illustrated instructions. Start by Building a Japanese Zero. This shows you all of the construction steps needed for any of the radial-engine models. Next, build the Flying Tigers' P-40. The P-40's in-line engine fuselage construction, and special features like the standard canopy are shared by other models, too. And, extra instructions are given for custom details, like the landing gear for the Achi "Val" dive bomber.

Use a model knife, or even a small disposable type, with a triangular blade for cutting out slots and the parts. Small scissors are useful for cutting curves, like wing tips. A straight edge as a cutting guide makes it easy to trim parts to shape. For easy building, please follow our instructions: Cut slots, score on the dashed lines, then cut out the part.

One can just bend the parts on the dashed lines, but accurate assembly will suffer. It's best to score along each dashed line. We use a dried out fine-line ballpoint pen, but any blunt blade, like a butter knife, will do. **HINT!** An *empty* ballpoint pen will still have a bit of ink. Some ink may come out from the heat of you hand. To be sure the pen is completely dry, close the air-vent hole with a drop of cement (the plastic "pencil-type" pens usually have the vent hole at the top end or under the eraser).

The best method of gluing the wing and tail parts together is with an ordinary glue stick -- Dennison's brand works well. Remember, that paper absorbs water and warps; **DO NOT LAMINATE THE WINGS AND TAIL WITH WATER-BASED GLUE!** In all cases, weight down the laminated parts and let dry. The wing and tail parts must be perfectly flat.

You can use a very light coat of water-based "White" glue for assembly. However, we've found that a household cement, like the Duco brand, works best. It dries fast, but slow enough so you can make minor adjustments in part alignment before it sets. For difficult parts, like a nose cone, put a very thin layer of cement on both parts. Let dry, then apply a second coat and assemble.

For a more realistic model, color the cut edges of all parts *before* assembly. Use a colored marker pen around the edges. During Assembly, after cutting off the tabs on the fuselage, color the cut edges of the tab with marker pens or colored pencils of the same color as the fuselage.

Our last suggestion is the penny weight. Our models were designed to use the early copper pennies for nose weight. Starting in 1983 the US. penny was lightened. Check the date and use pennies dated 1982 or earlier. Or if you have to use the light pennies, and the model stalls, add a tiny piece of modeling clay to the nose. Or, better yet, cement a small paper clip inside of the cowl (in addition to the penny) during assembly. **HINT!** Experiment with a radial-engine model. Complete the nose cowling but don't cement in place until after your flight test.

Build, Fly and above all, HAVE FUN!



FLY'N THINGS™

Penny Weight Paper Models Building & Flying Instructions

1. Use These:



White Glue Or
Model Cement

Score Folds With A
Used Up (No Ink)
Ball-Point Pen

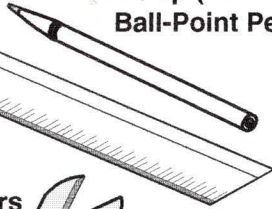

Glue Stick

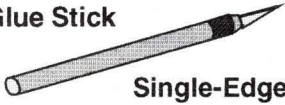

Single-Edge
Razor Blade
Or Model Knife



Scissors

Metal-Edge
Ruler Or
Straight Edge

2. AND, Tape And A
Cutting Board:

Tape

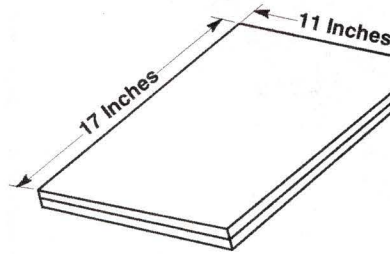

Two Layers Of
Corrugated Cardboard,
Taped Together Around
All Of The Edges.

3. Score Along Dotted Line Of Wing With The
Used Ball-Point Pen Or A Smooth-Edge
Butter Knife And Fold Down.

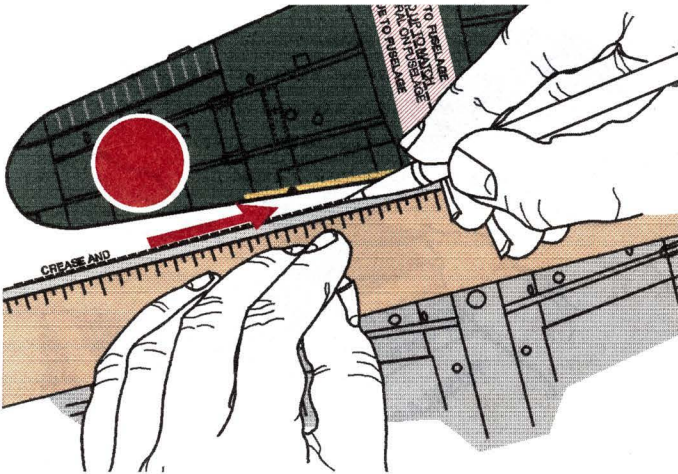

4. With Printed Side Down,
Coat ONE Inside Surface
With The Glue Stick.



Make Sure That You
Cover The Complete
Wing Area With A Thin
Coat From The Glue Stick.

5. Place Wing On A Flat Surface, Fold Down
And Smooth Out Glue. Weight Down So
The Glued Wing Dries Flat.

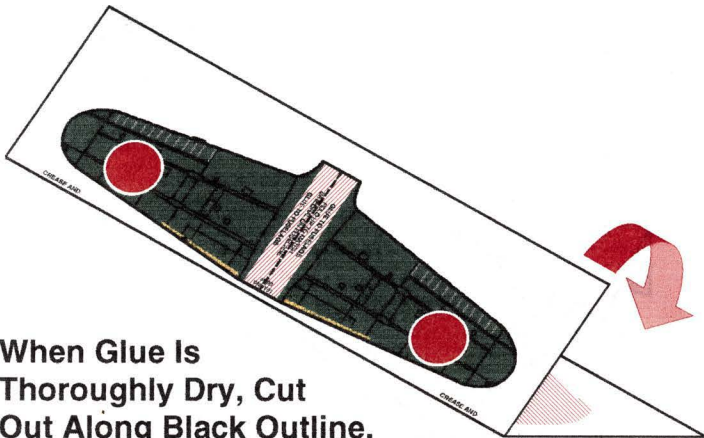

When Glue Is
Thoroughly Dry, Cut
Out Along Black Outline.

6. Score, Fold And Glue
The TAILPLANE And RUDDER
The Same Way You Did The WING.

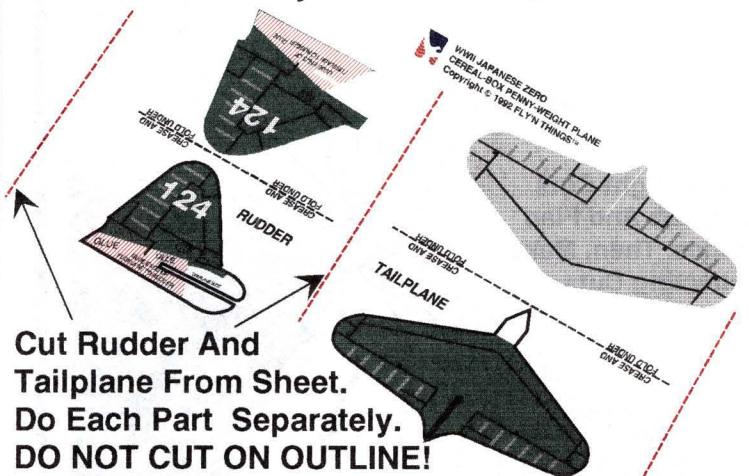

Cut Rudder And
Tailplane From Sheet.
Do Each Part Separately.
DO NOT CUT ON OUTLINE!

19. After Cowl Is Curved And Folded, Shape Around Cowl Front.

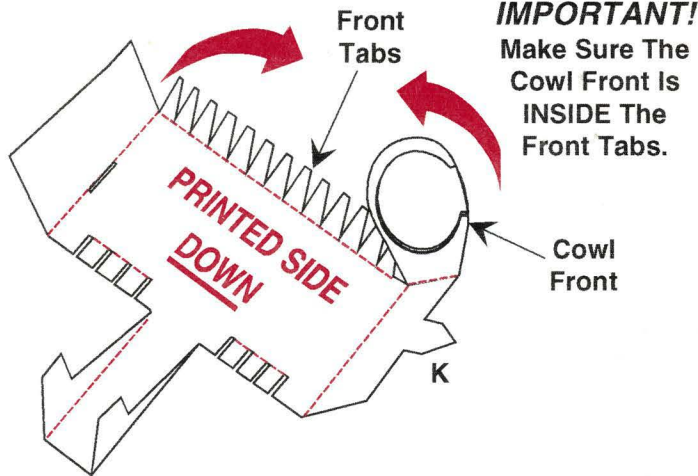

20. Pull Tab Through Slot, And Glue Bottom Of Cowl. Align And Hold Until Dry. Glue Front Of Cowl And Fold Down Tabs.

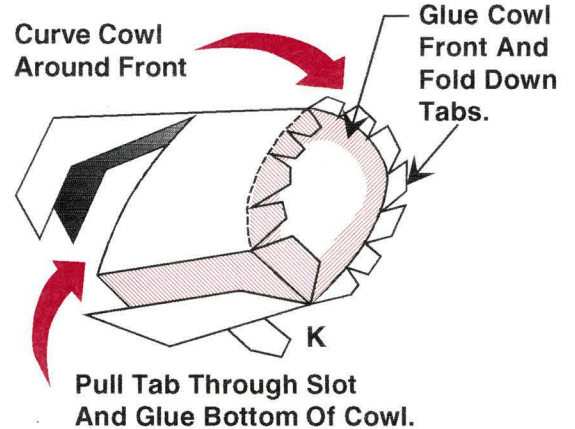

21. When Tabs At Front Of Cowl Are In Place, Turn The Cowl As Shown And Hold Firmly Until Dry.



22. Check To Make Sure All Tabs Are Glued Flat To The Front Of Cowl. Reglue If Needed. Then, Trim The Bottom Tab Flush With Side.

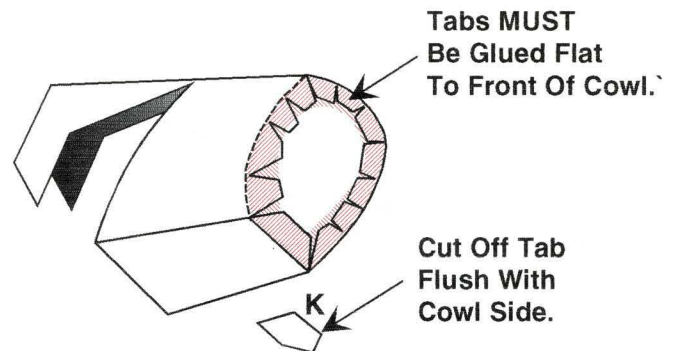

NOSE CONE ASSEMBLY

23. Cut Slot In Outside Nose Cone. Cut To Outline And Curve Over A Pen As You Did The Cowl.

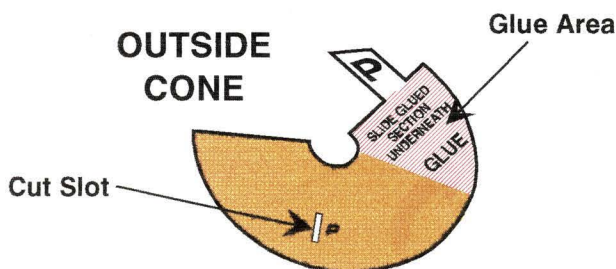

24. Apply Glue To Red-Hatched Area. Pull Tab Through Slot. Curve The Outside Around. Hold Until Dry.

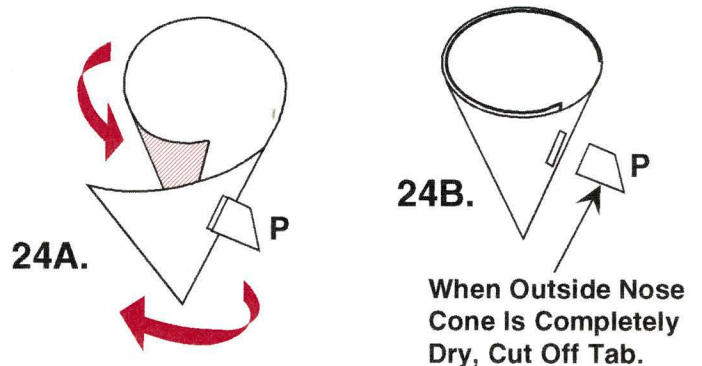

25. As You Did With The Outside Cone, Cut Slot And Curve Inside Cone. Then, Bend Tabs Up.

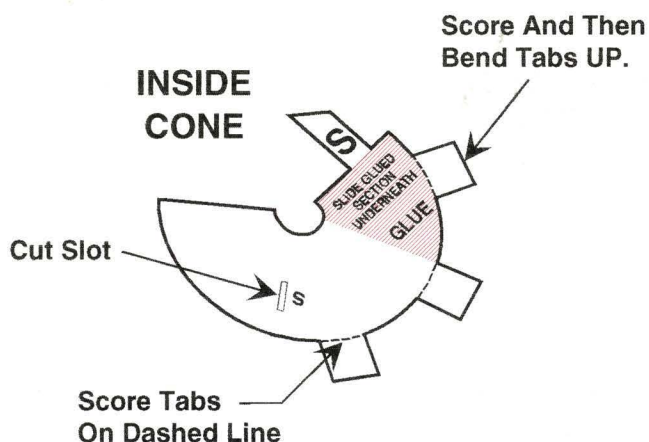

26. Apply Glue To Red-Hatched Area. Pull Tab Through Slot. Curve The Outside Around. Hold Until Dry.

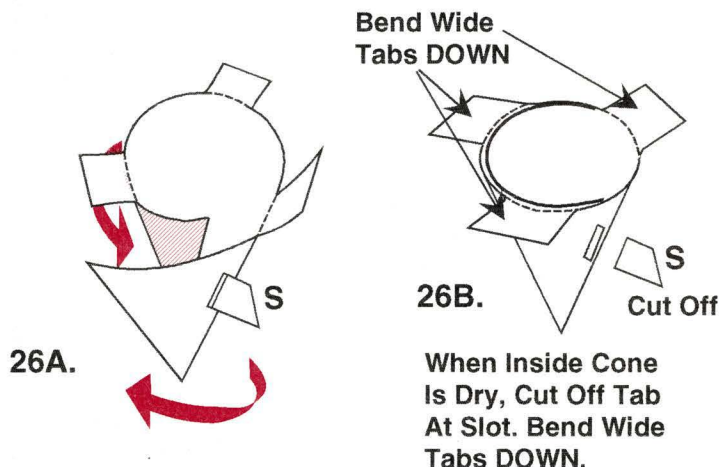

27. Cut Out White Center Disk Of Cowl Trim. Then, Cut Out Cowl Trim On Outline. Insert INSIDE Cone From Back . Glue In Place.

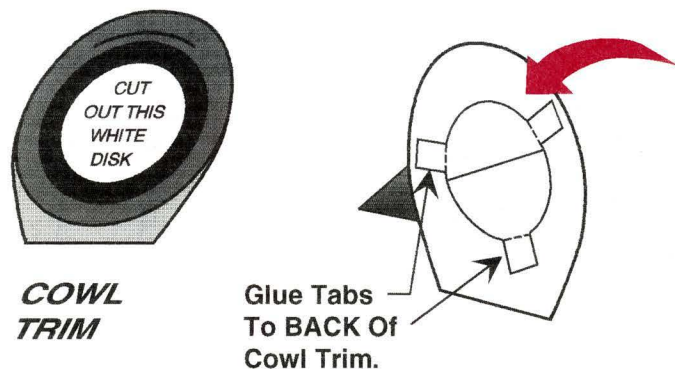

28. Apply Plenty Of Glue To The Inside Cone. Slip The Outside Cone On Top. Hold Until Dry.

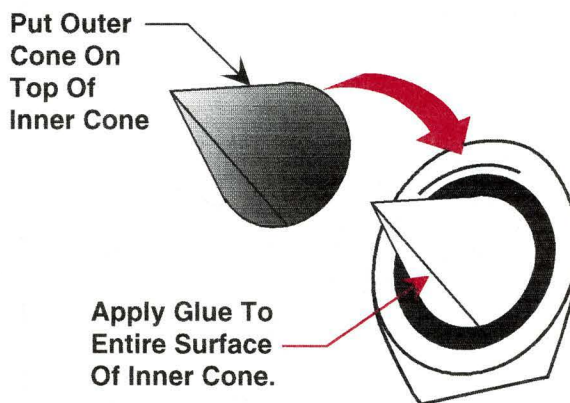

29. Apply A Coat Of Glue To The Back Of The Cowl Trim And The Front Of The Cowling. Press Parts Together.

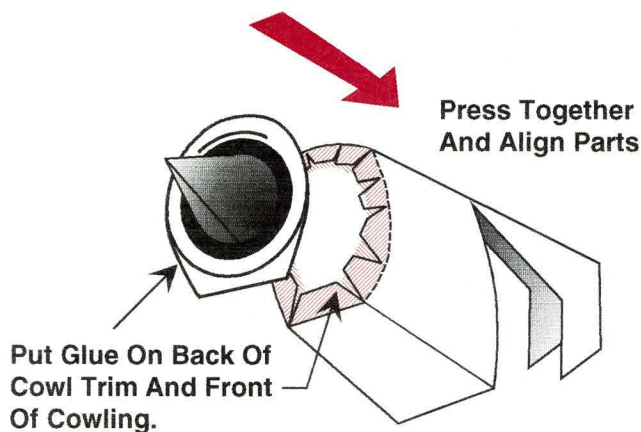

30. Check Alignment, and Smooth Cowl-Trim Edges Down. Hold Parts Together Until Dry.

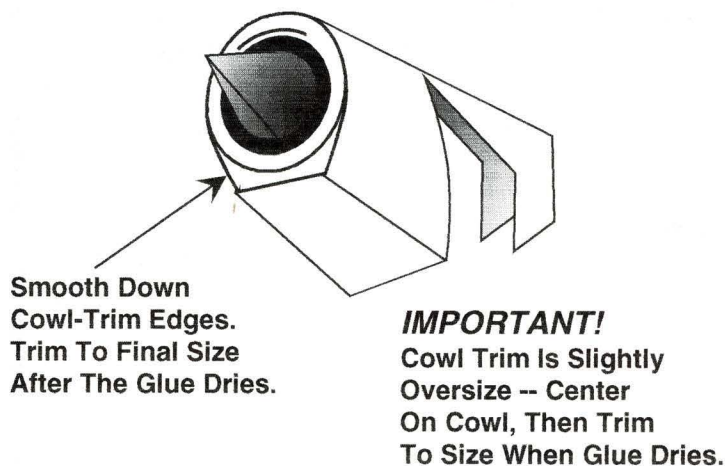

BUBBLE CANOPY ASSEMBLY

31. Cut Out The Canopy Along The Outlines. Make Sure All Slots Are Cut Out As Indicated On Part.

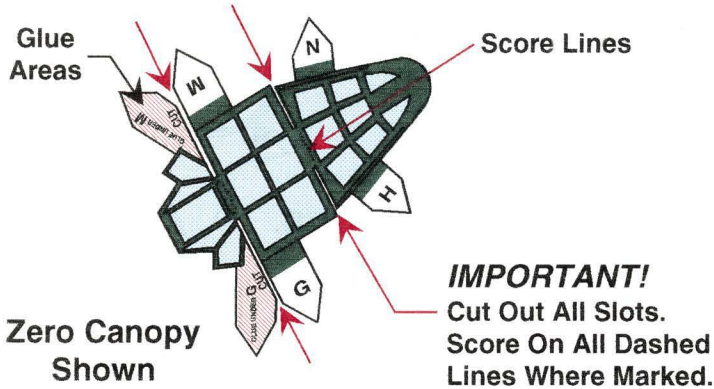

32. ROLL... Do Not Fold Top Of Canopy. Fold Only On The Dashed Lines.

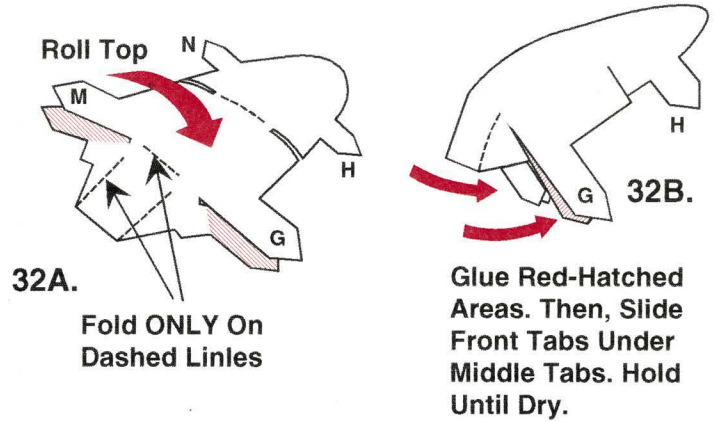

STANDARD CANOPY ASSEMBLY

33. Like The Bubble Canopy, Cut Along Outline, Making Sure That All Slots Are Cut Out.

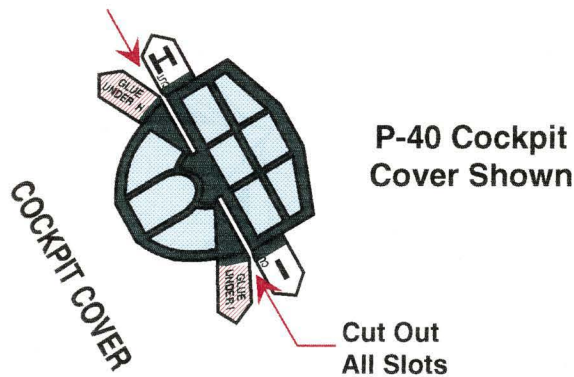

34. Roll Canopy. Fold ONLY On Dashed Lines.

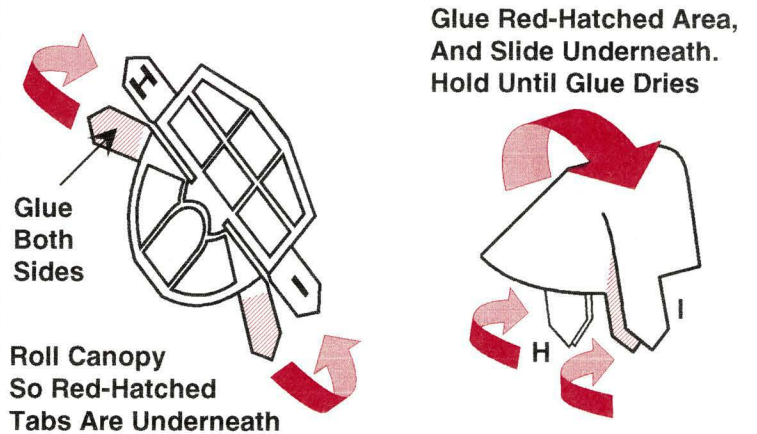

FINAL ASSEMBLY RADIAL-ENGINE PLANES

35. Coat Red-Hatched Area Of Rudder With Glue. Slide Tailplane All Of The Way In. Then, Slide Rudder In.

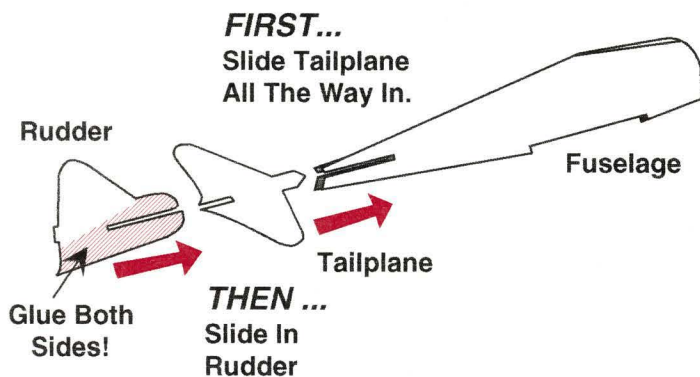

36. Glue Ends Of Fuselage To Rudder. Check Vertical And Horizontal Alignment Of Rudder And Tailplane. Hold Until Glue Dries.

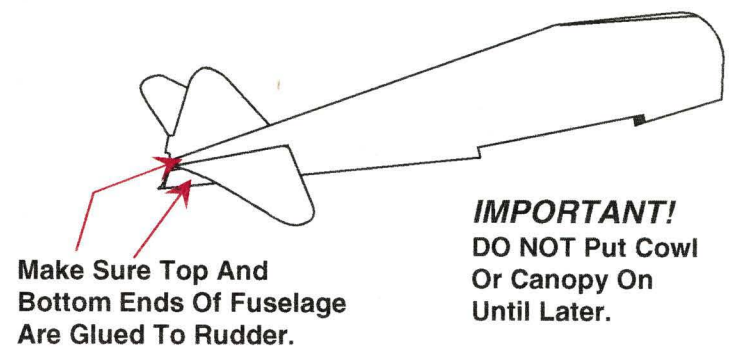

37. Apply Glue To The Red-Hatched Cowl-Mounting Areas. Then, Slide The Cowl All The Way On Over The Fuselage.

IMPORTANT!

DO NOT ATTACH COWL IF THE PLANE HAS A BELLY PAN. SEE STEPS 43 THROUGH 46.

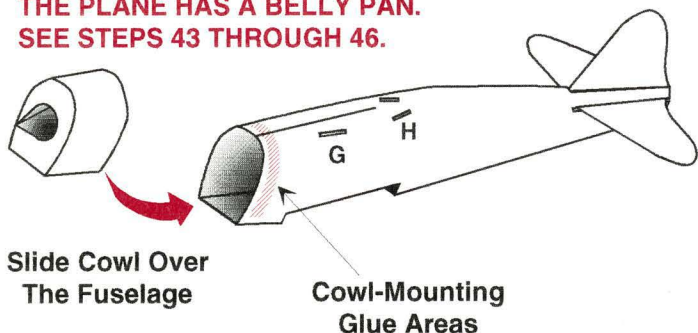

38. For Planes With A Top-Panel Extension On The Cowl, Hook Tabs Into Fuselage Slots As You Slide The Cowl On.

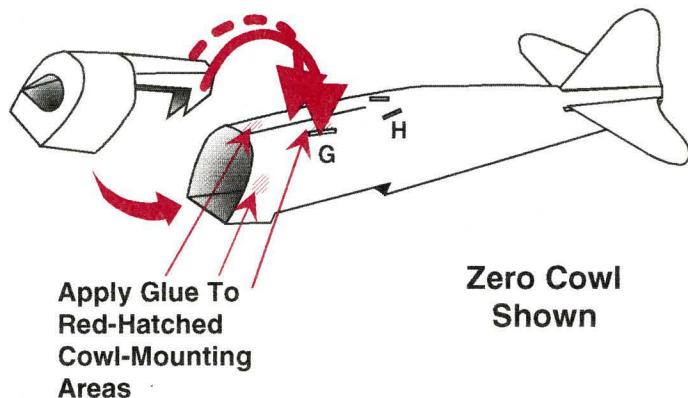

39. Cement Glue Spots Next To Canopy Slots. Slide Canopy In Place. Hold Until Dry.

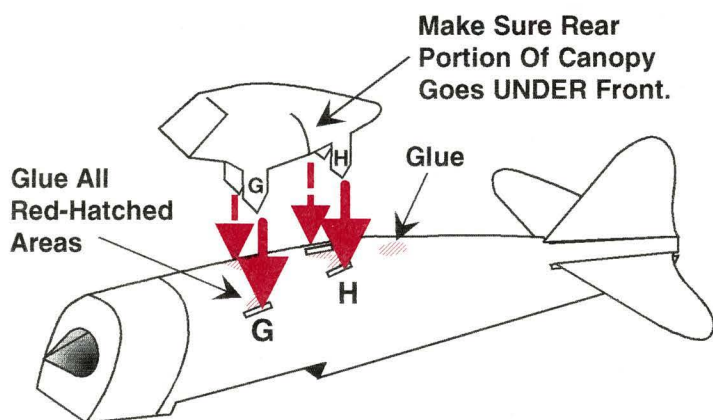

40. For Planes With Cowl Extension, Make Sure The Front Tabs Of The Canopy Go On The Outside.

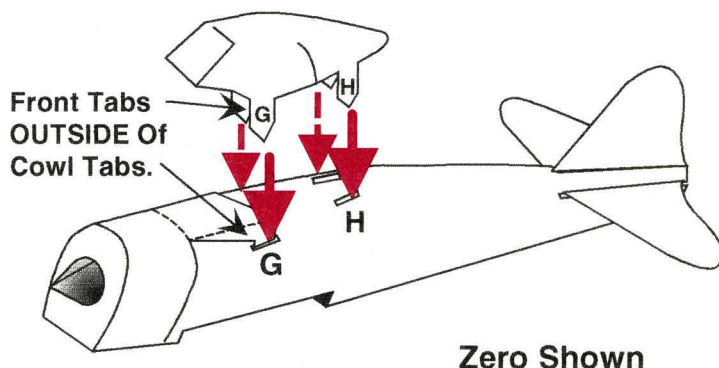

41. Standard Canopies Mount In The Same Way. Make Sure Rear Part Of Canopy Overlaps The Front.

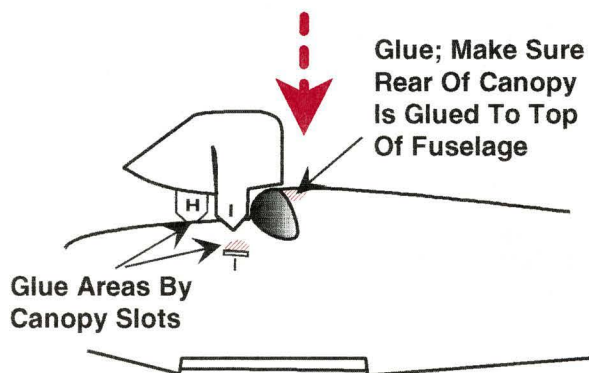

42. Fold Wing Up EXACTLY Along The Dashed Line In Glue Area. Glue Wing FIRMLY To Bottom Of Fuselage. Hold Until Dry.

Bend Wing At Dashed Line To Match Bottom Of Fuselage Angle. Use Plenty Of Glue!

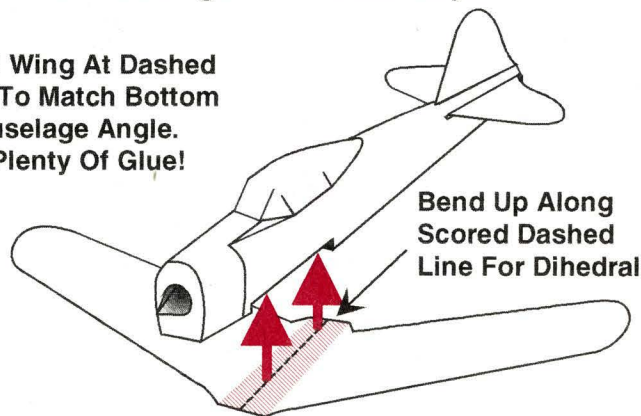

BELLY PAN ASSEMBLY

43. Score Along Dashed Lines.
Cut Out Belly Pan On Outline.

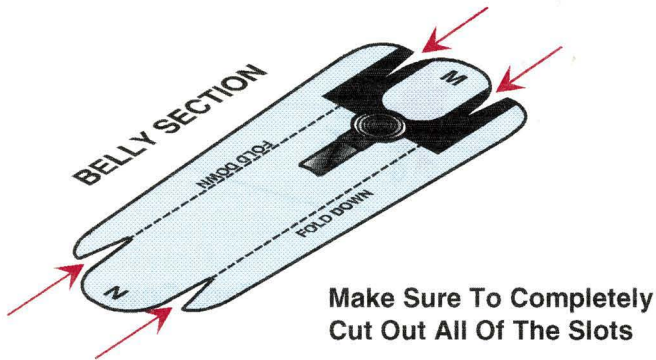

44. Fold DOWN On Both
Of The Dashed Lines

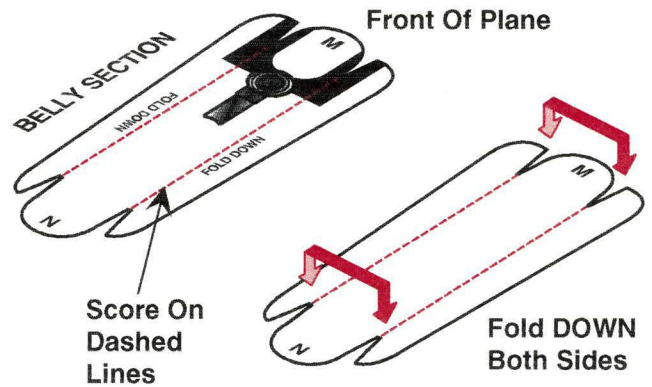

45. Glue Red-Hatched Areas
For The Belly Pan. Place
In Position. Hold Until Dry.

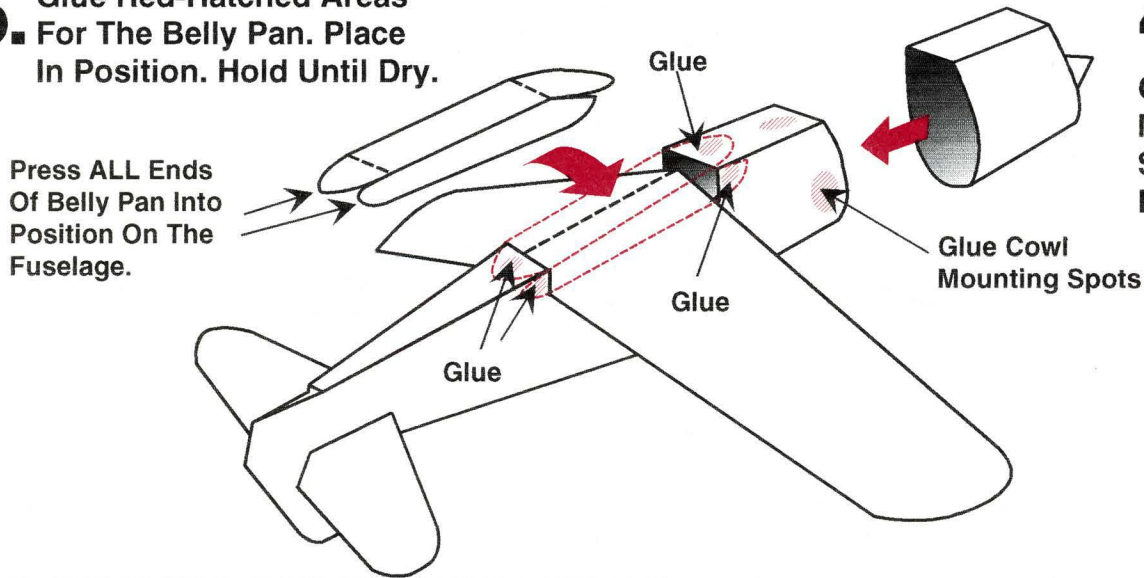

46.
Glue Cowl
Mounting Areas.
Slide Cowl Into
Position.

Hellcat
Shown

ADDING FINAL DETAILS

47. Roll Air Scoop And Fold Down
On Scored, Dashed Lines.

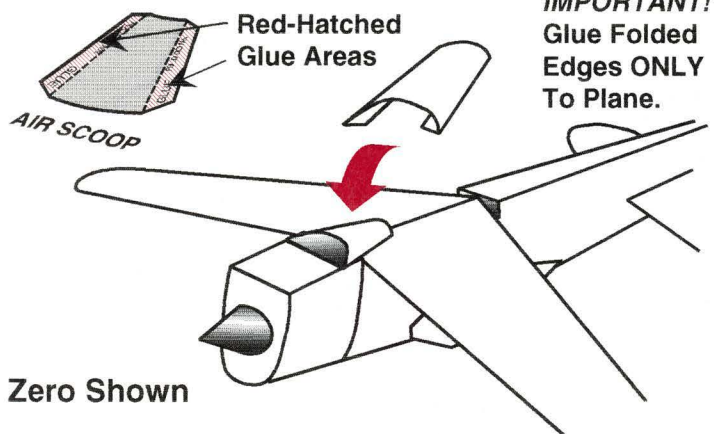

48. Top Scoops Are Installed
The Same Way. Make Sure
Patterns On Scoop And
Fuselage Match!

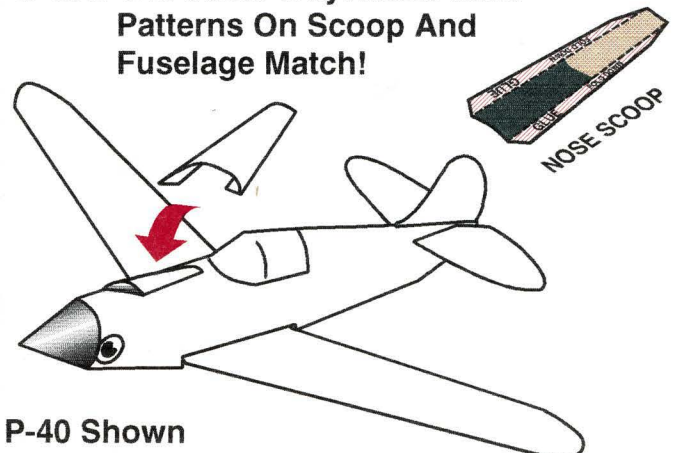

FIXED LANDING GEAR

49. Score Along All Dashed Lines. Cut Out Landing Gear On Outline.

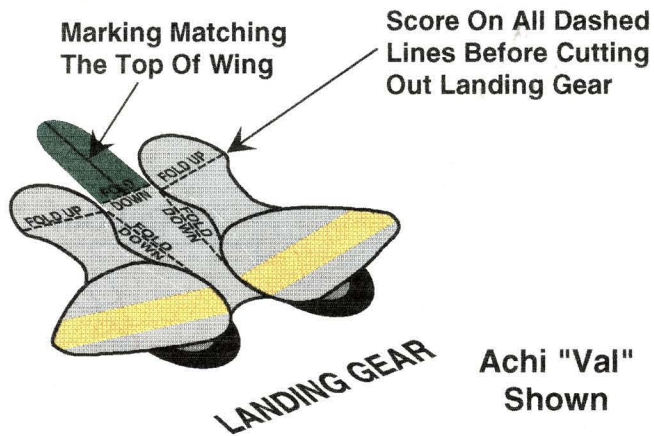

50. Fold DOWN On Dashed Lines AS Shown.

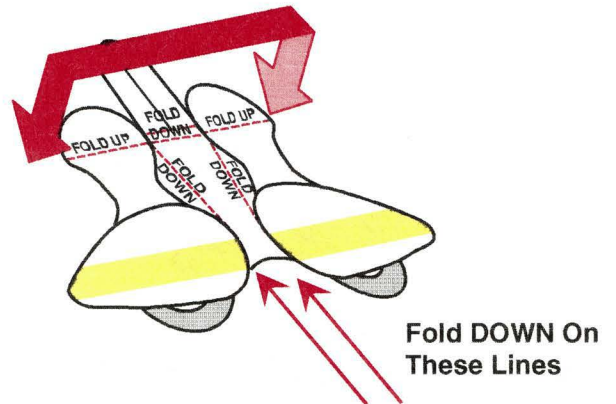

51. Fold Down Top Tabs As Shown. Glue INNER Surfaces At Back Of Fairing And At Bottom Of Wheel.

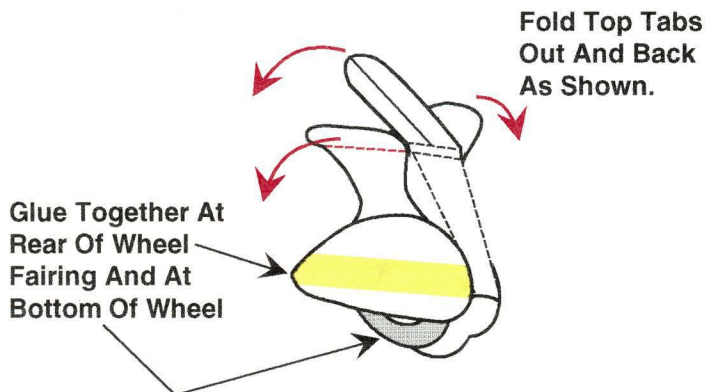

52. Glue Red-Hatched Areas On Top And Bottom Of the Wing. Slide Landing Gear Over Wing. Press Down Tabs.

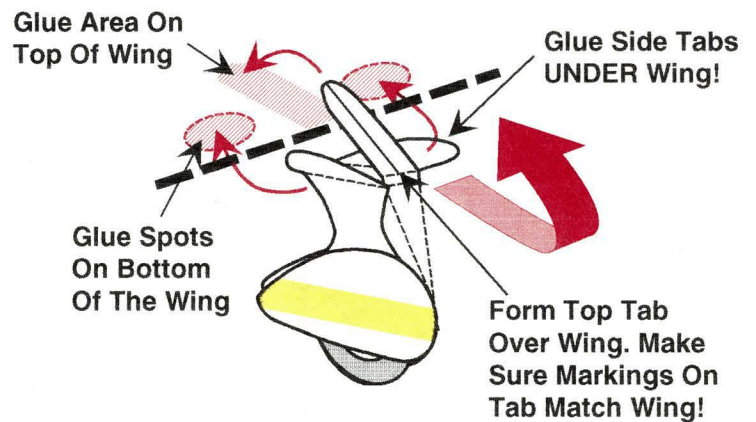

RADIATOR AND COWLING

53. Typical Nose Radiator And Bottom Cowling. Score On Dashed Lines. Then, Cut Out On Outlines.

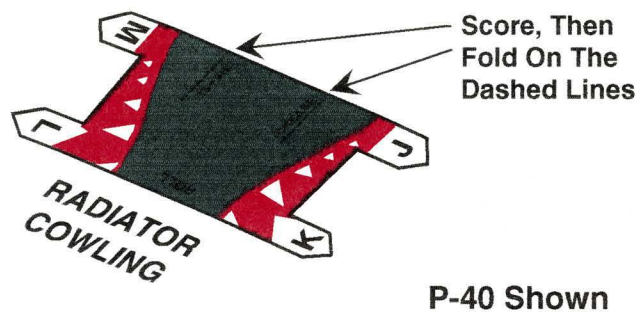

54. Glue Red-Hatched Mouting Areas. Slide Tabs Into Slots. Hold Until Dry.

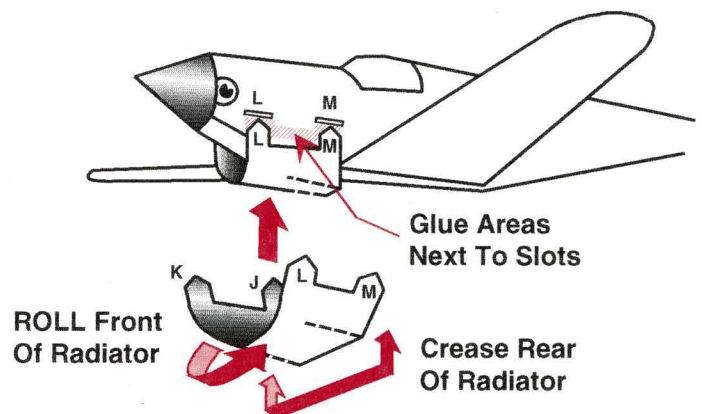

INLINE-ENGINE FUSELAGE

55. Typical Inline-Engine Fuselage.

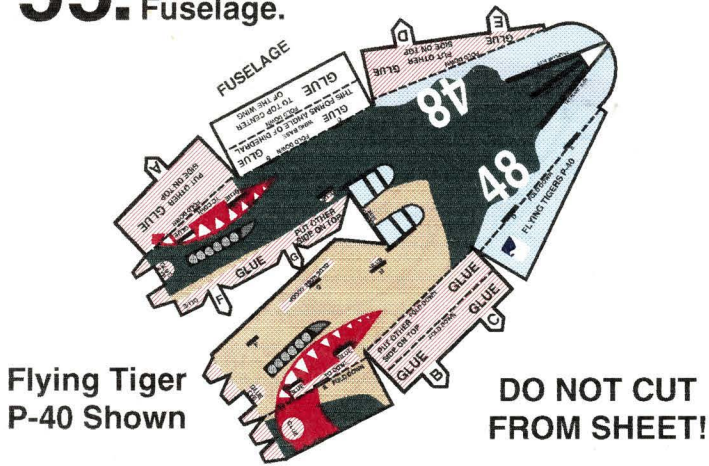

56. Referring To Step 57, Follow The Instructions of Steps 9 Through 11 To Score, Cut Slots And Cut Out The Fuselage.

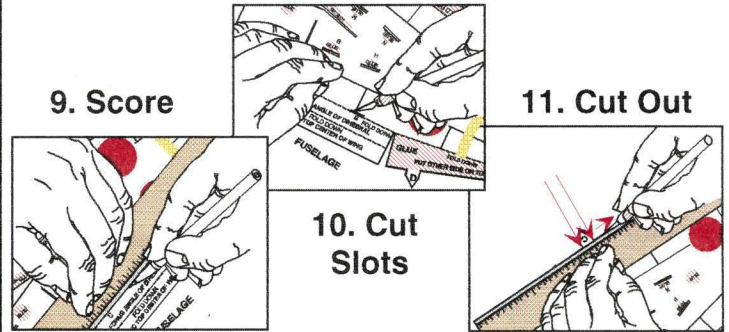

57. Refer To Building Steps 9 Through 11.

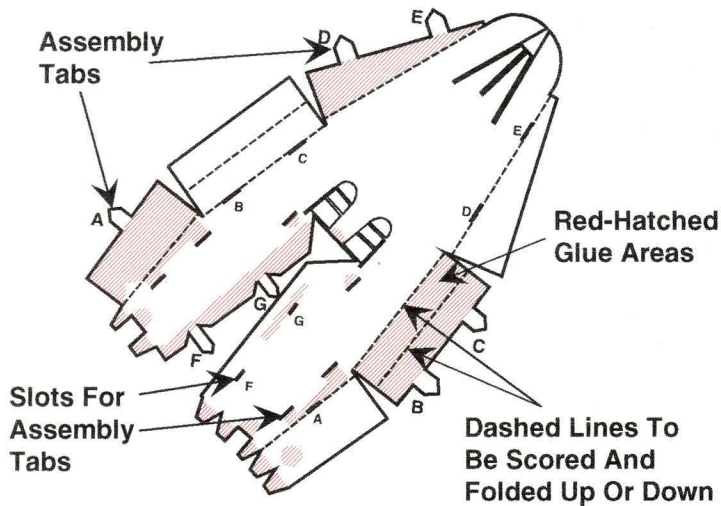

58. Fold Scored Creases Up Or Down As Marked On The Dashed Lines.

CAUTION!
Do Not Bend Nose Tabs At Glue Area

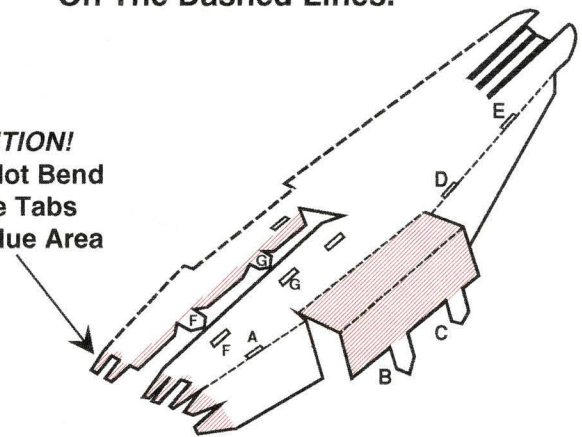

59. Push All Bottom Tabs Through The Matching Slots. Apply A Light Coat Of Glue To The Red-Hatched Areas. Pull Tabs Tight, Hold Until Completely Dry.

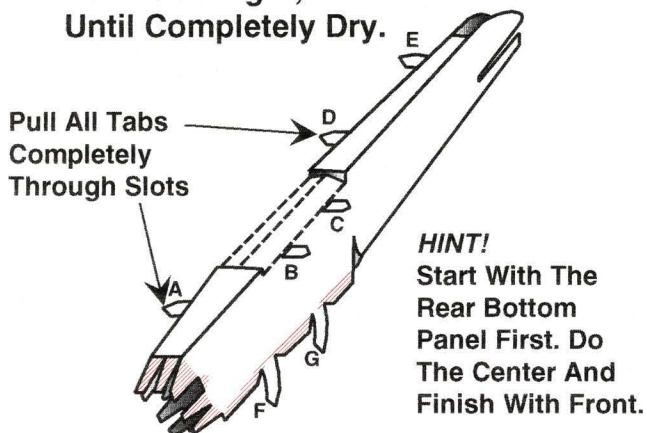

60. Glue Hatched Area At The Top, Front Of Fuselage. Pull Top Tabs (F And G) Completely Through. Line Up Markings. Hold Until Dry.

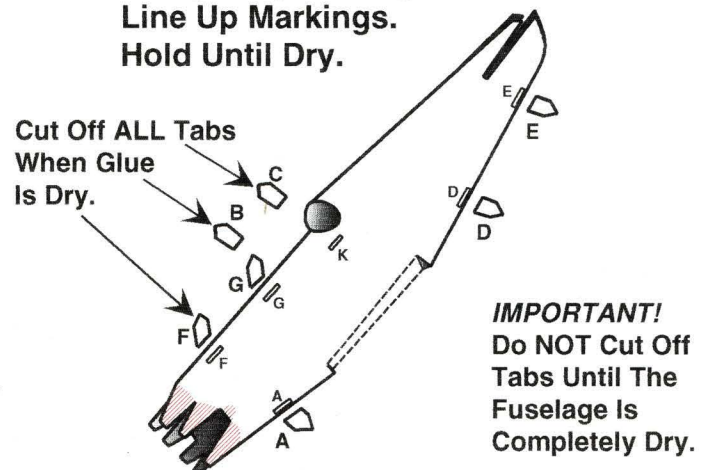

67. As You Did With The Inside Cone, Score Dashed Lines, Cut Out Slot, Cut To Outline And Curve The Cone .

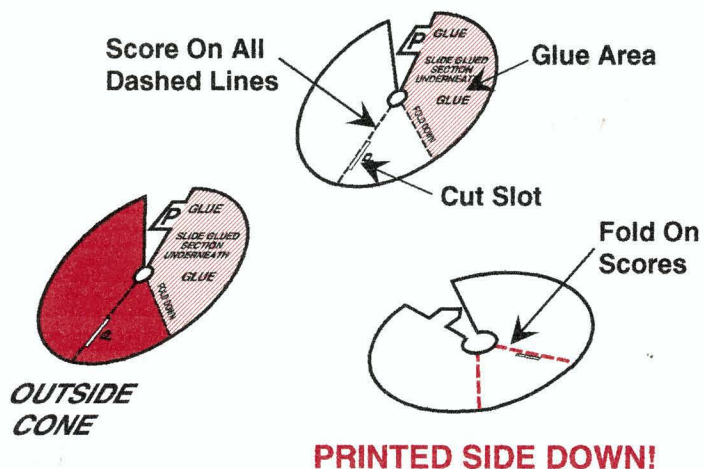

68. Apply Glue To Red-Hatched Area. Pull Tab Through Slot, Curve The Outside Around. Hold Until Dry.

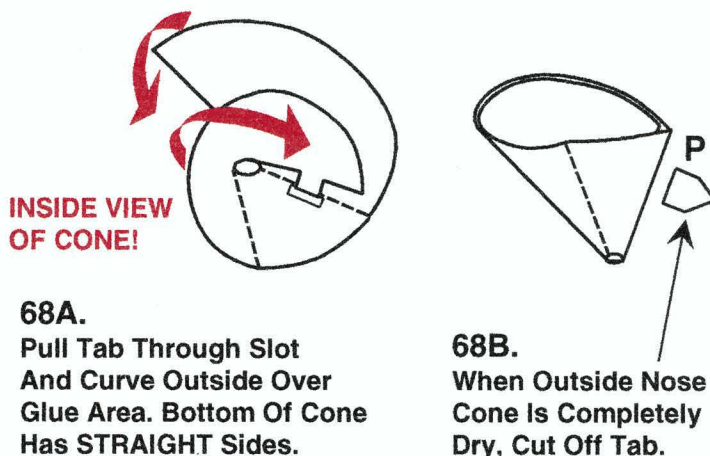

69. Apply Plenty Of Glue To The *INSIDE* Of The Cone. Force The Nose Tabs Into The Cone.

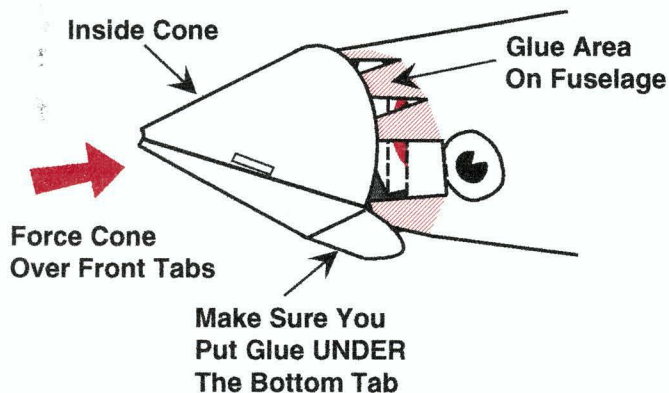

70. Hold Inside Nose Cone Against Fuselage. Bend The Bottom Tab Against Fuselage. Hold Cone And Tab Until Glue Dries.

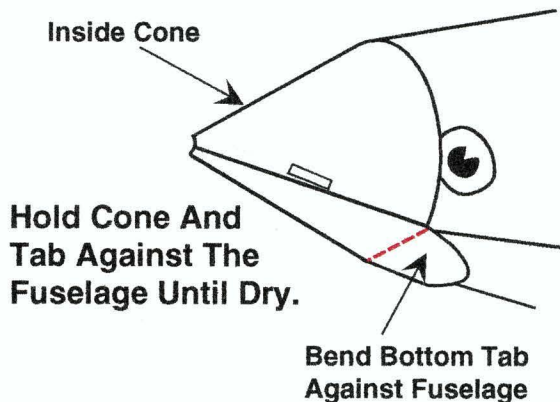

71. Apply Plenty Of Glue To The Inside Nose Cone. Firmly Press The Outside Cone On Top.

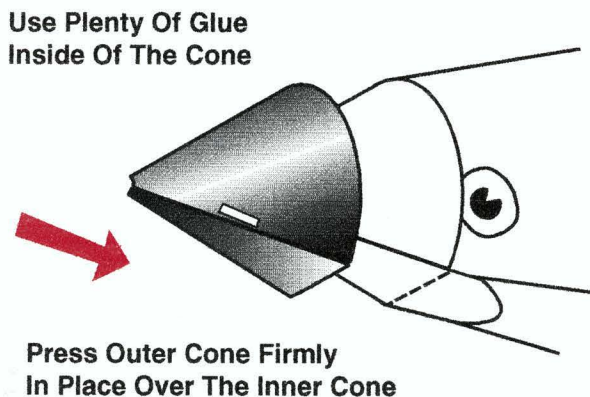

72. Hold Cone Until Dry. Finish Construction By Adding Tail, Wings, Canopy And Details As You Did For The Radial-Engine Planes.

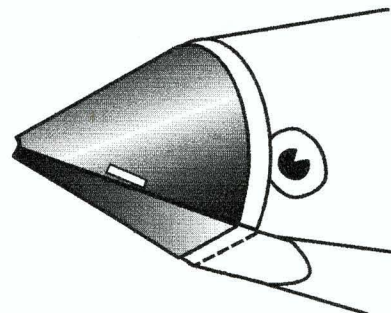

FLY PLANE LIKE YOU THROW A DART!

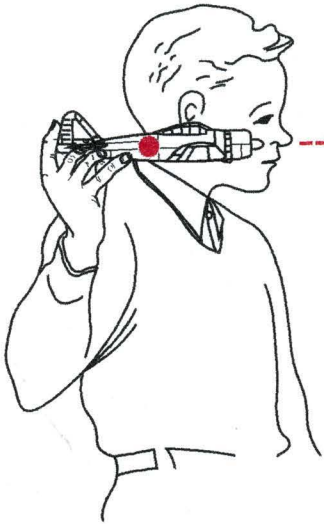

Throw Your Plane With A Smooth, Steady LEVEL Motion. After You Get Used To How Your Model Flies, You'll Be Able To Do "Stunts," Too. A Hard Throw, With The Nose Pointing UP, Gives A Loop! Or, Try Tilting Your Plane For A Hard Banking Turn.

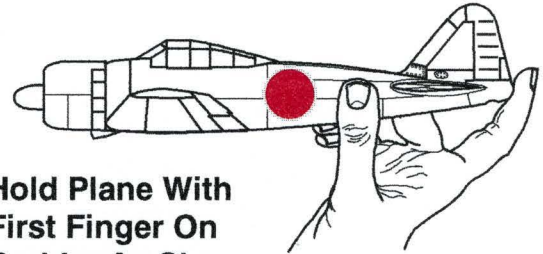

Hold Plane With First Finger On Rudder As Shown

ADJUSTING YOUR PLANE FOR FLIGHT



When Properly Made, Your Model Should Look Like This: Proper Dihedral And Correct Position Of The Rudder And Tailplane

If Your Plane Hits Something And Dents The Wing, Smooth Out Dent With Your Fingers. Keep Wings FLAT - DO NOT Curve Or Bend.



The Rudder Must Be Straight - NOT Curved Or Twisted. It Must Be Vertical And In Line With The Fuselage.

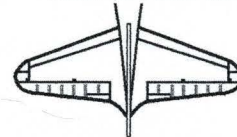

RIGHT

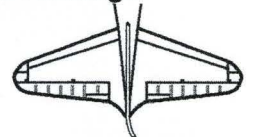

WRONG!

FLY WITH G-LINE INDOORS OR OUT!

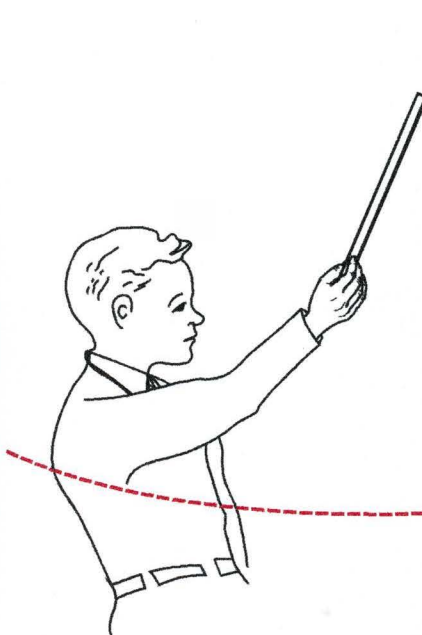

For Great Fun Indoors Or Out! Any Of Your Models Fly With G-Line Control. You'll Soon Learn To Make Them Loop And Even Have "Dog Fights" With A Friend. This Picture Shows All That's Needed.

Tie A Thin String Or Thread To A Short Stick. Thread The Other End Of The Line Into The Wing As Shown Below. Start With 6 To 8 Feet Of Line. Swing The Stick Around Your Head From Right To Left.

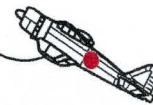

Your Plane Will Rise And Fly At The End Of The G-Line. It Obeys Your Every Move For Speed And Control. You Will Soon Be Able To Perform Loops, Dives And Landings.

Tie A Light Line To The Leading Edge Of The Wing Near The Tip. Thread Line Through The Wing With A Needle. Tie A Large Knot.

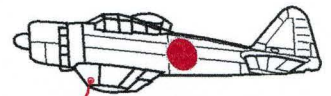

PENNY-WEIGHT HOLDER

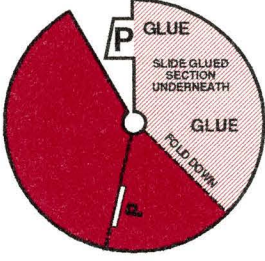
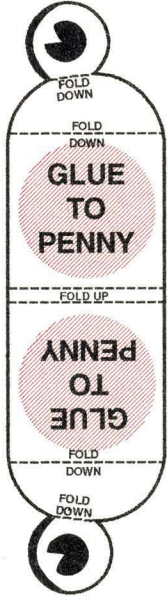

OUTSIDE CONE

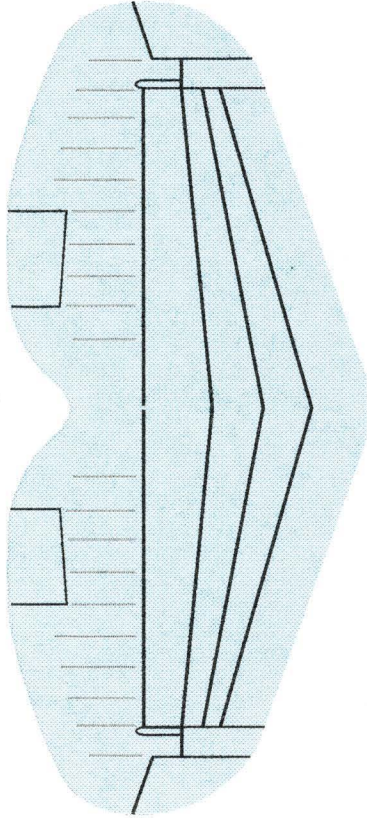

CREASE AND FOLD UNDER

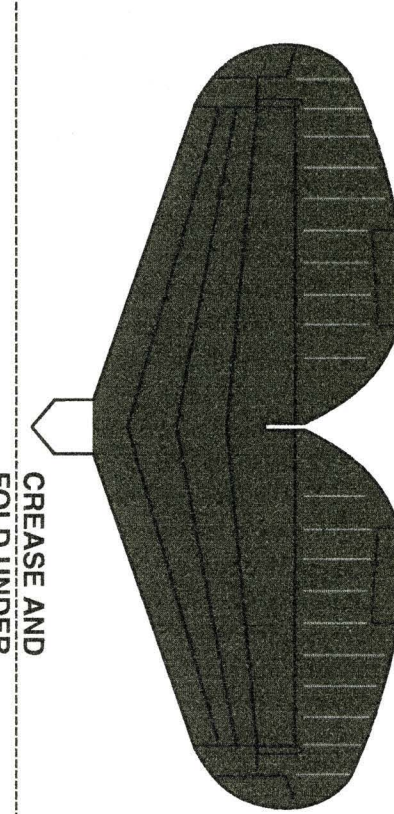

TAIL PLANE

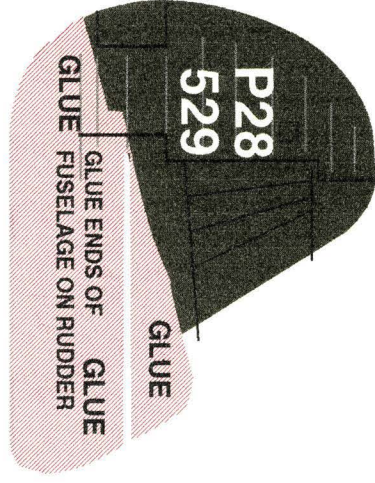

CREASE AND FOLD UNDER

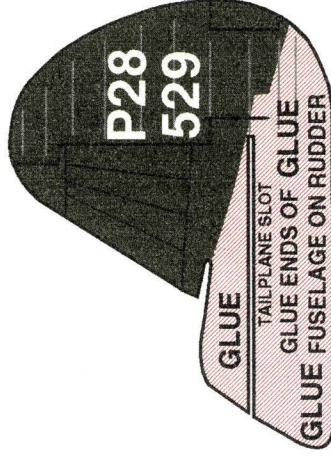

RUDDER

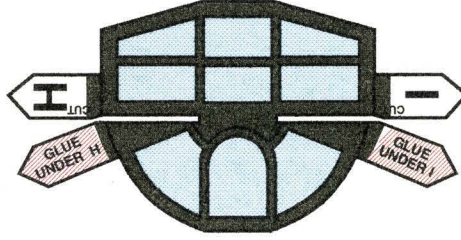

COCKPIT COVER



**WWII AMERICAN P-40 WARHAWK
CEREAL-BOX PENNY-WEIGHT PLANE**
Copyright © 1993 FLY'N THINGS™

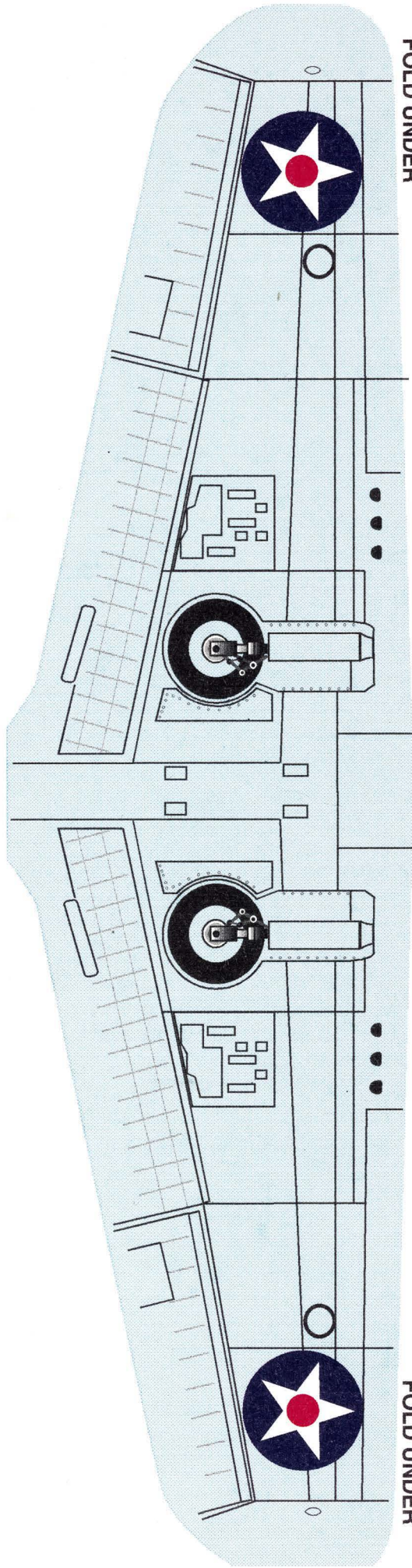

CREASE AND
FOLD UNDER

CREASE AND
FOLD UNDER



LEADING EDGE

GLUE TO FUSELAGE
FOLD UP TO MATCH
DIHEDRAL ON FUSELAGE
GLUE TO FUSELAGE

WING



WWII AMERICAN P-40 WARHAWK
CEREAL-BOX PENNY-WEIGHT PLANE
Copyright © 1993 FLY'N THINGS™

**PENNY-WEIGHT
HOLDER**

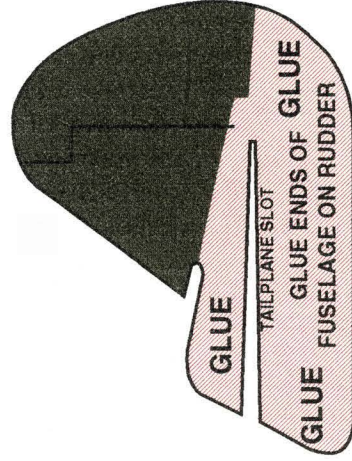
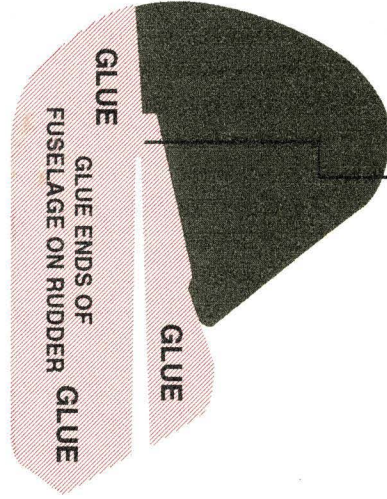
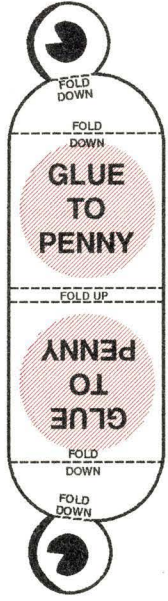

RUDDER

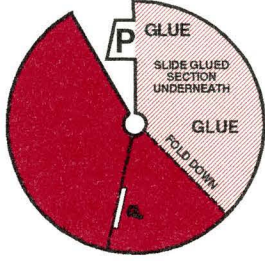

**OUTSIDE
CONE**

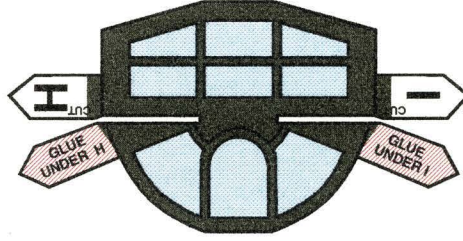

COCKPIT COVER

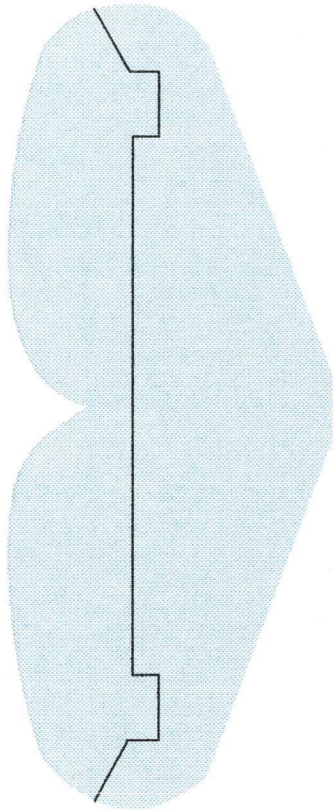

CREASE AND FOLD UNDER

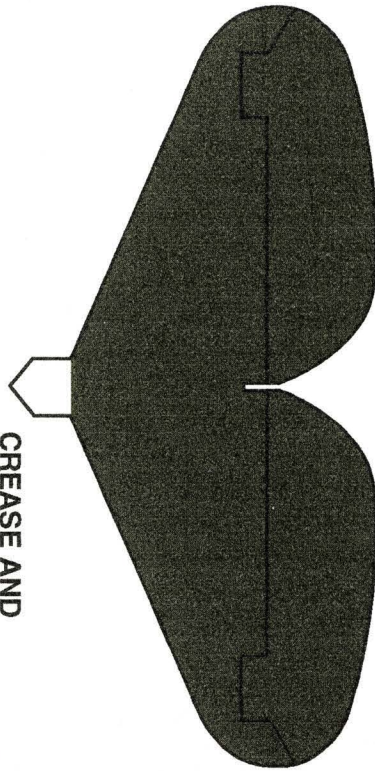

TAIL PLANE



**WWII AMERICAN P-40 WARHAWK
CEREAL-BOX PENNY-WEIGHT PLANE**
Copyright © 1993 FLY'N THINGS™

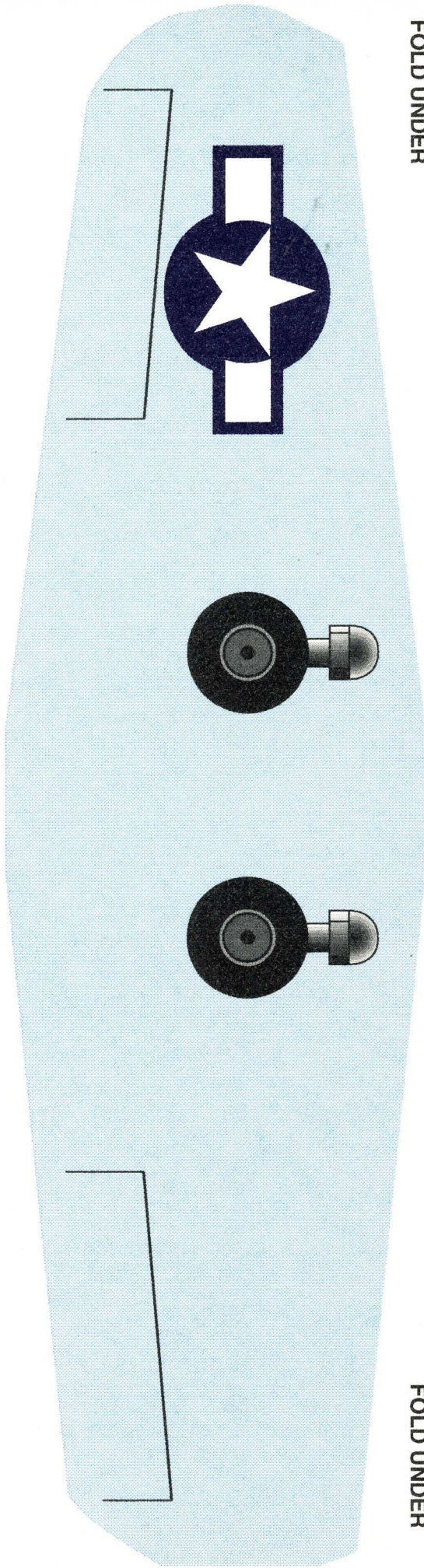

CREASE AND
FOLD UNDER

CREASE AND
FOLD UNDER



LEADING EDGE
GLUE TO FUSELAGE
FOLD UP TO MATCH
DIHEDRAL ON FUSELAGE
GLUE TO FUSELAGE

WING



WWII AMERICAN P-40 WARHAWK
CEREAL-BOX PENNY-WEIGHT PLANE
Copyright © 1993 FLY'N THINGS™

WWII JAPANESE ZERO
 CEREAL-BOX PENNY-WEIGHT PLANE
 Copyright © 1992 FLY'N THINGS™

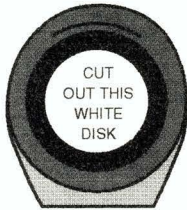

TRIM TO FINAL SIZE
 AFTER ASSEMBLY
 TO FRONT OF COWL

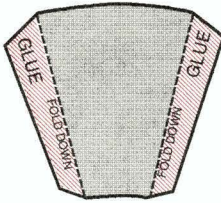

RADIATOR

COWL

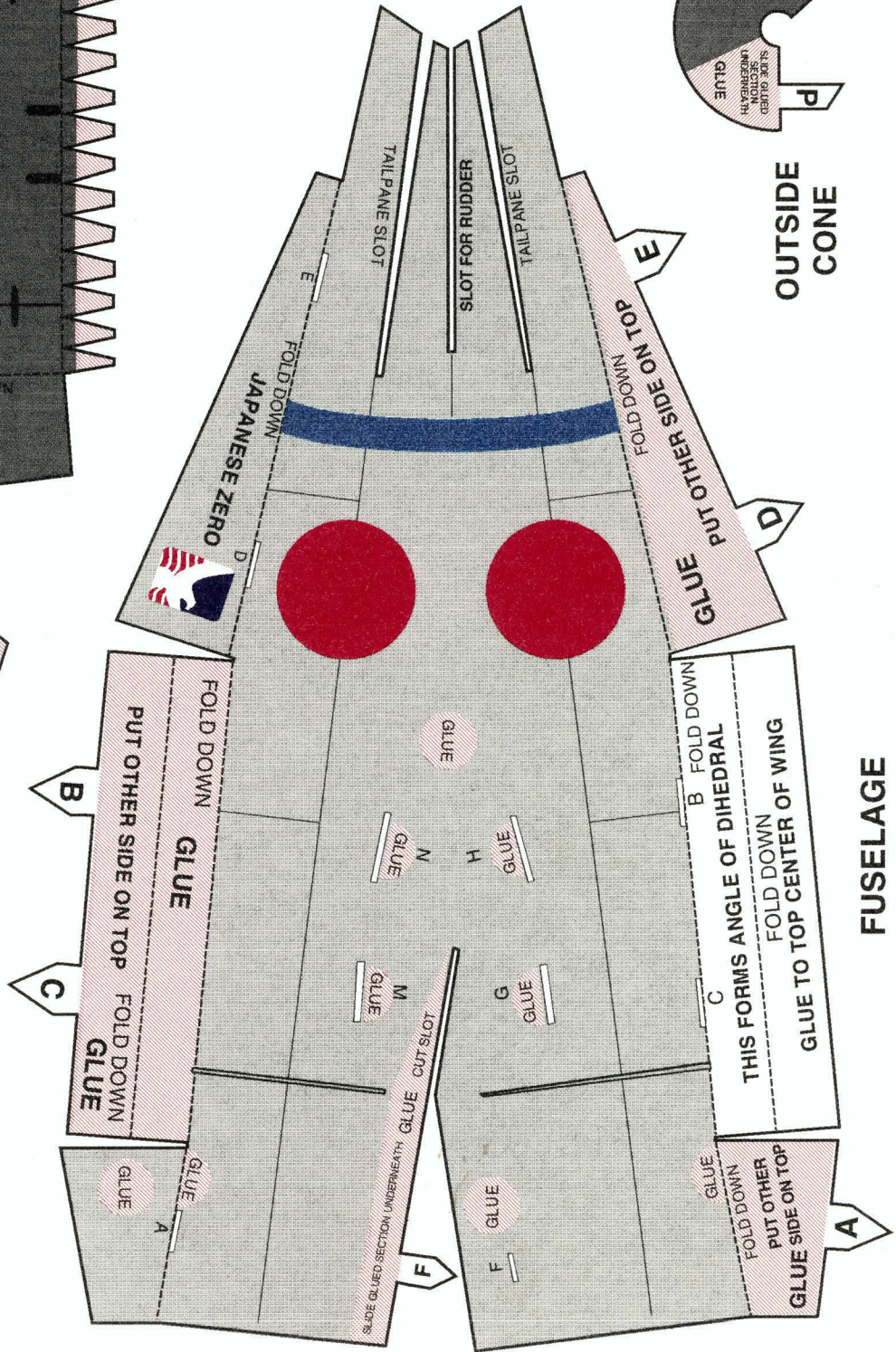
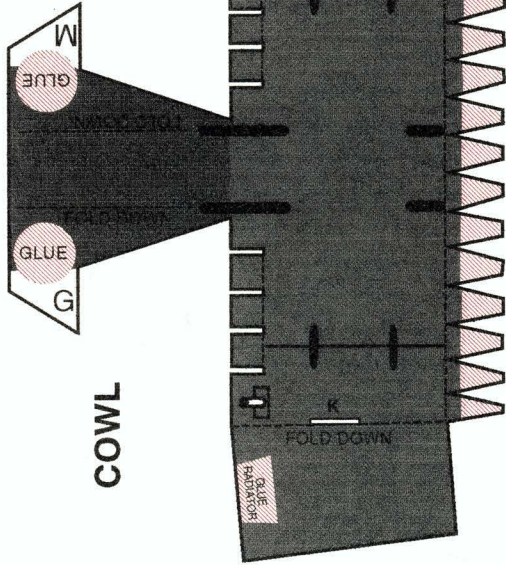

FUSELAGE

OUTSIDE CONE

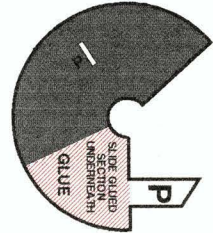

INSIDE CONE

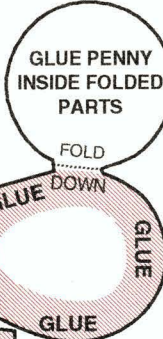
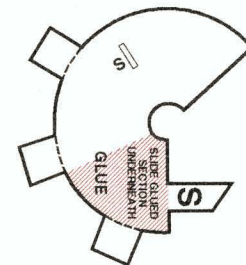

CREASE AND
FOLD UNDER

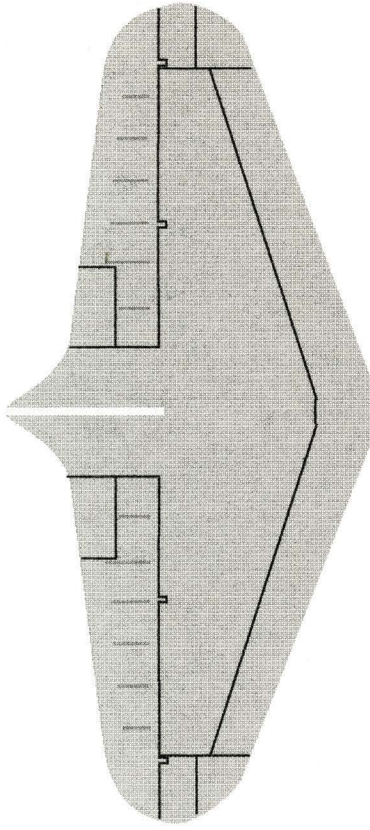

CREASE AND
FOLD UNDER

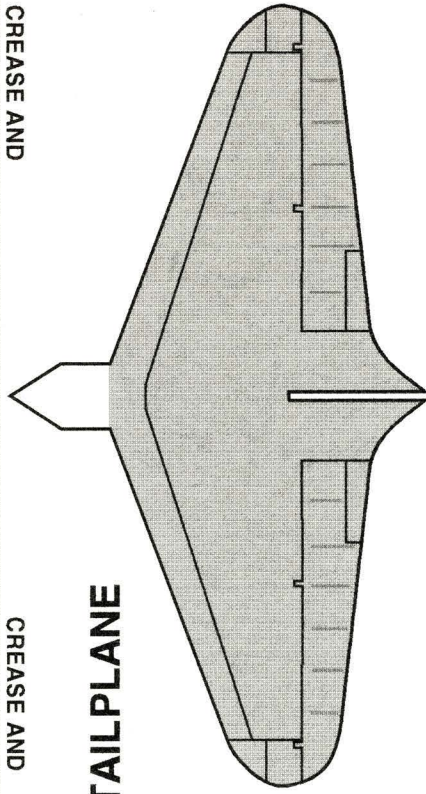

TAILPLANE

WWII JAPANESE ZERO
CEREAL-BOX PENNY-WEIGHT PLANE
Copyright © 1992 FLY'N THINGS™

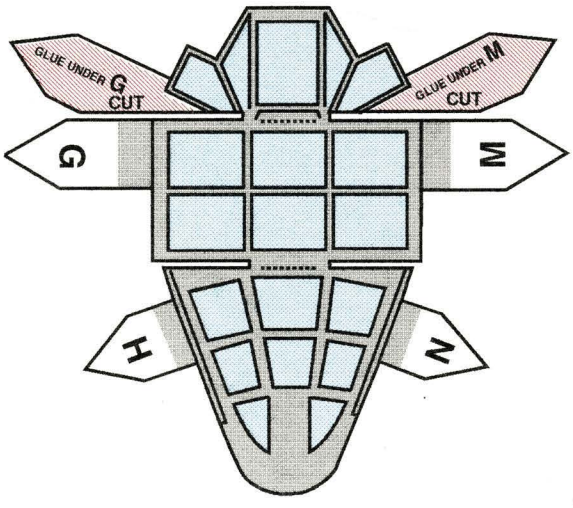

COCKPIT COVER

CREASE AND
FOLD UNDER

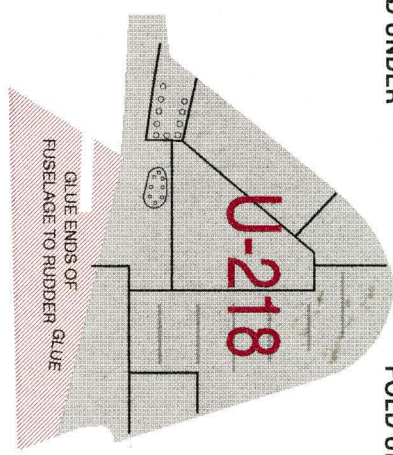

CREASE AND
FOLD UNDER

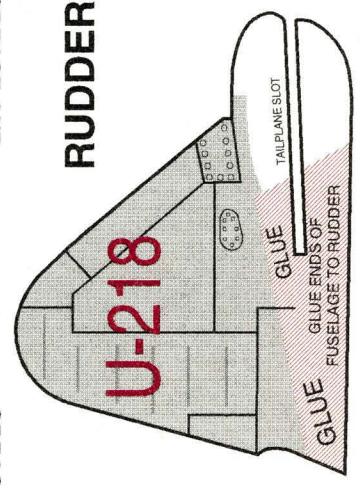

RUDDER

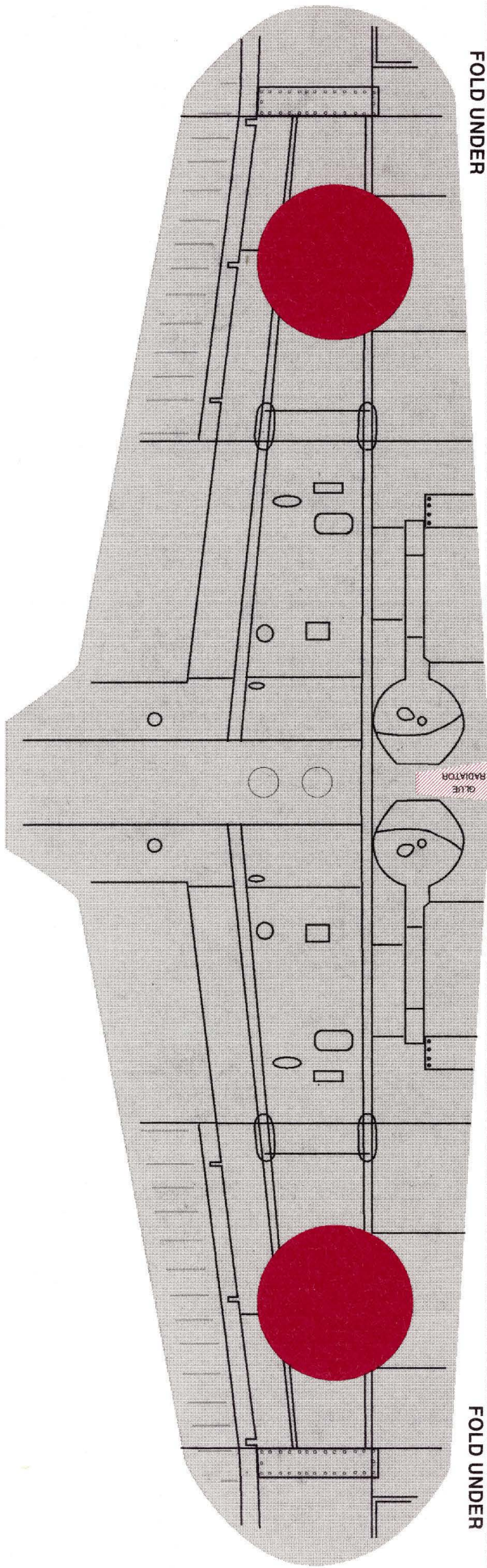

CREASE AND
FOLD UNDER

CREASE AND
FOLD UNDER

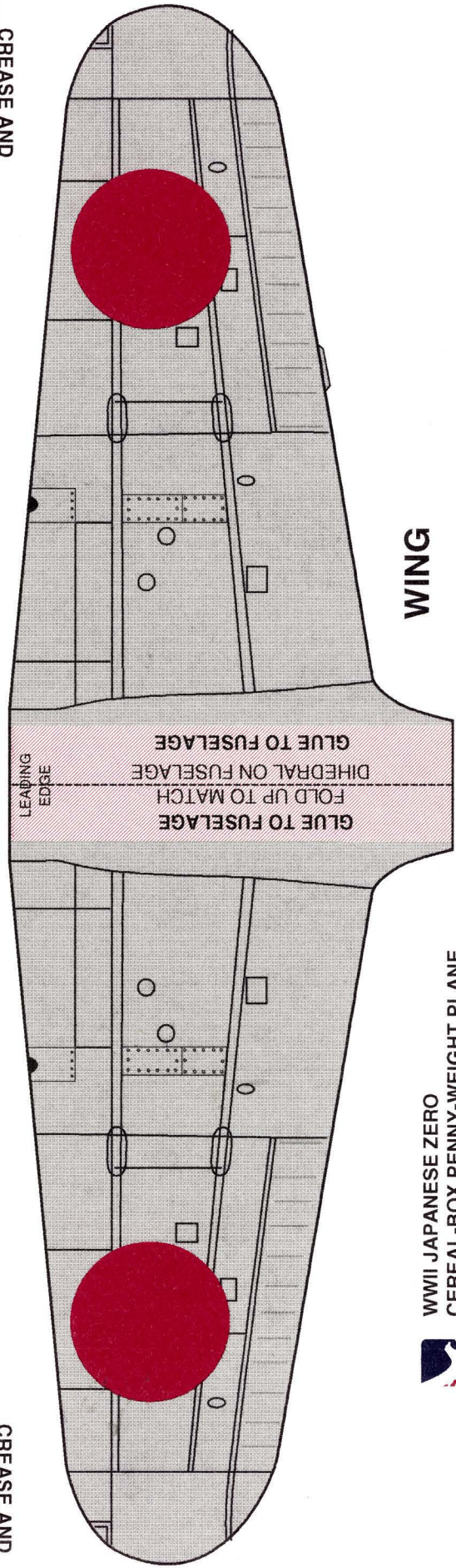

WING

LEADING
EDGE

GLUE TO FUSELAGE
FOLD UP TO MATCH
DIHEDRAL ON FUSELAGE
GLUE TO FUSELAGE

WWII JAPANESE ZERO
CEREAL-BOX PENNY-WEIGHT PLANE
Copyright © 1992 FLY'N THINGS™



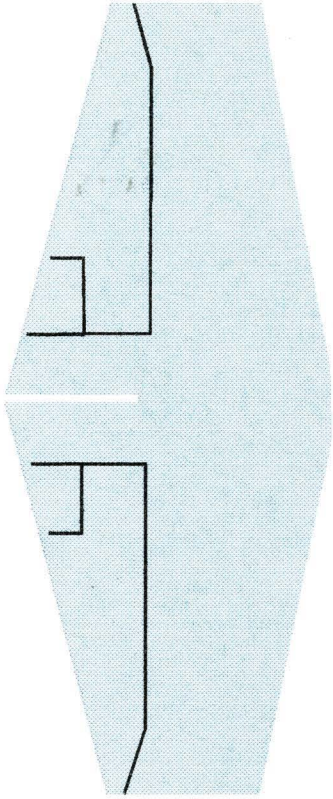

CREASE AND
FOLD UNDER

CREASE AND
FOLD UNDER

TAIL PLANE

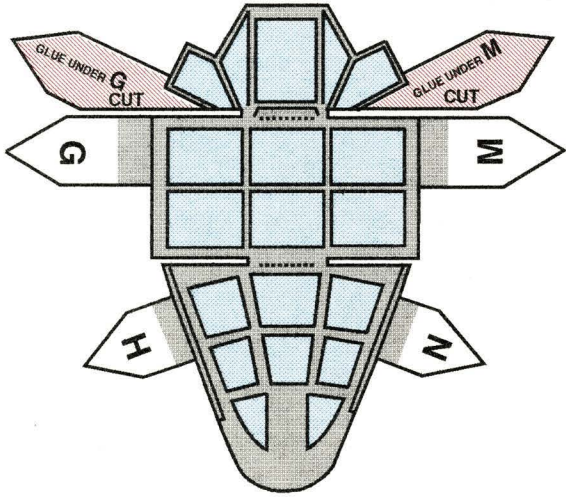
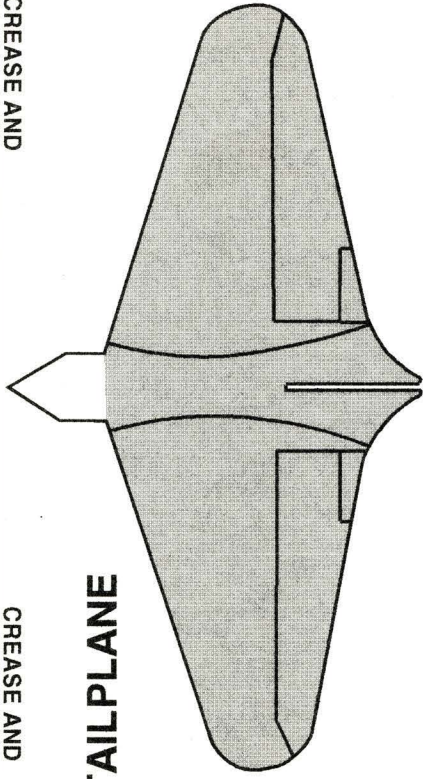

**COCKPIT
COVER**

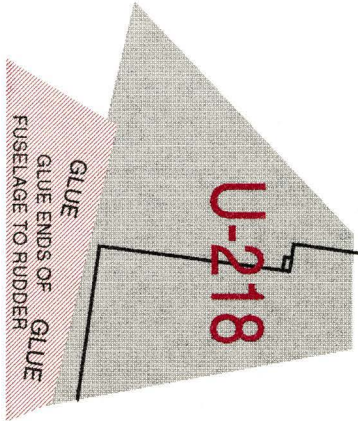

CREASE AND
FOLD UNDER

CREASE AND
FOLD UNDER

RUDDER

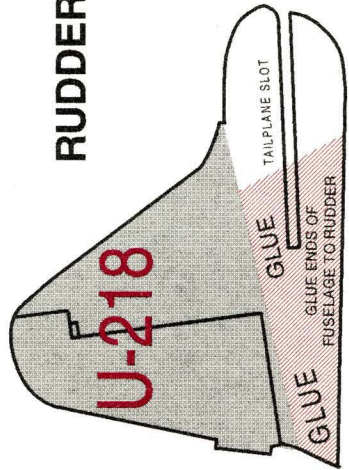

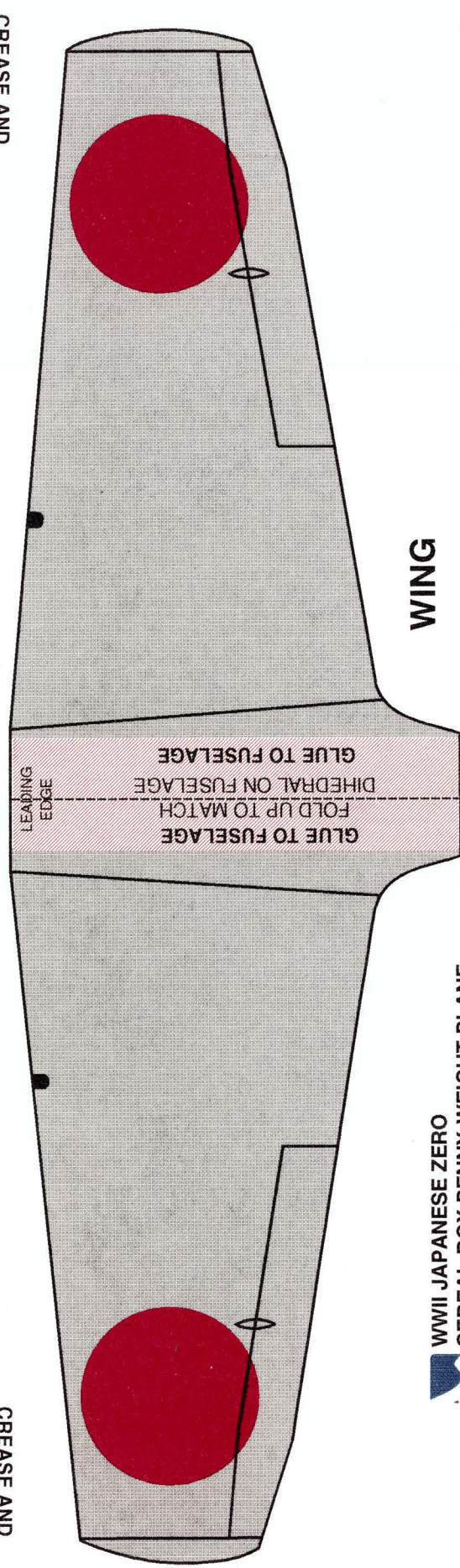
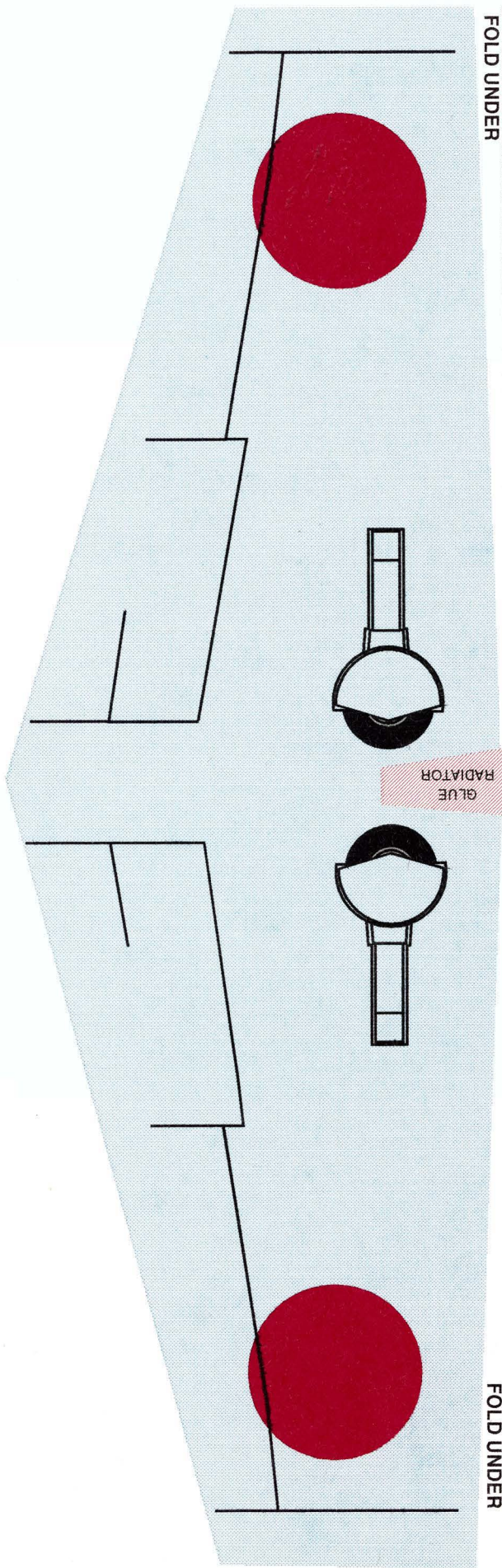



WWII JAPANESE ZERO
 CEREAL-BOX PENNY PLANE
 Copyright© 1992 FLY'N THINGS™

RADIATOR

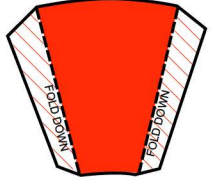

COCKPIT COVER

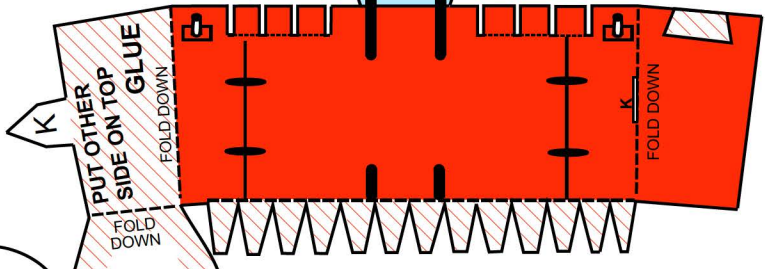
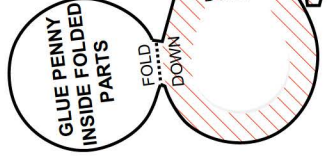
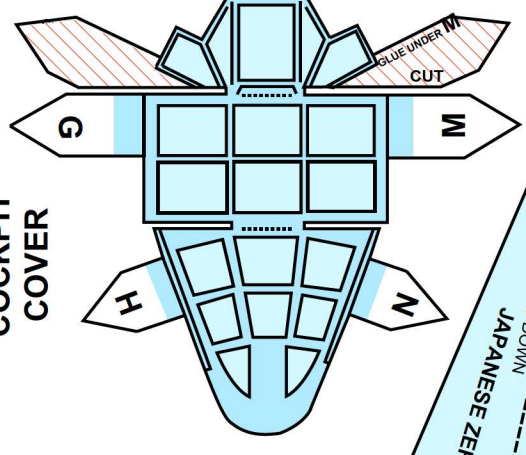

COWL

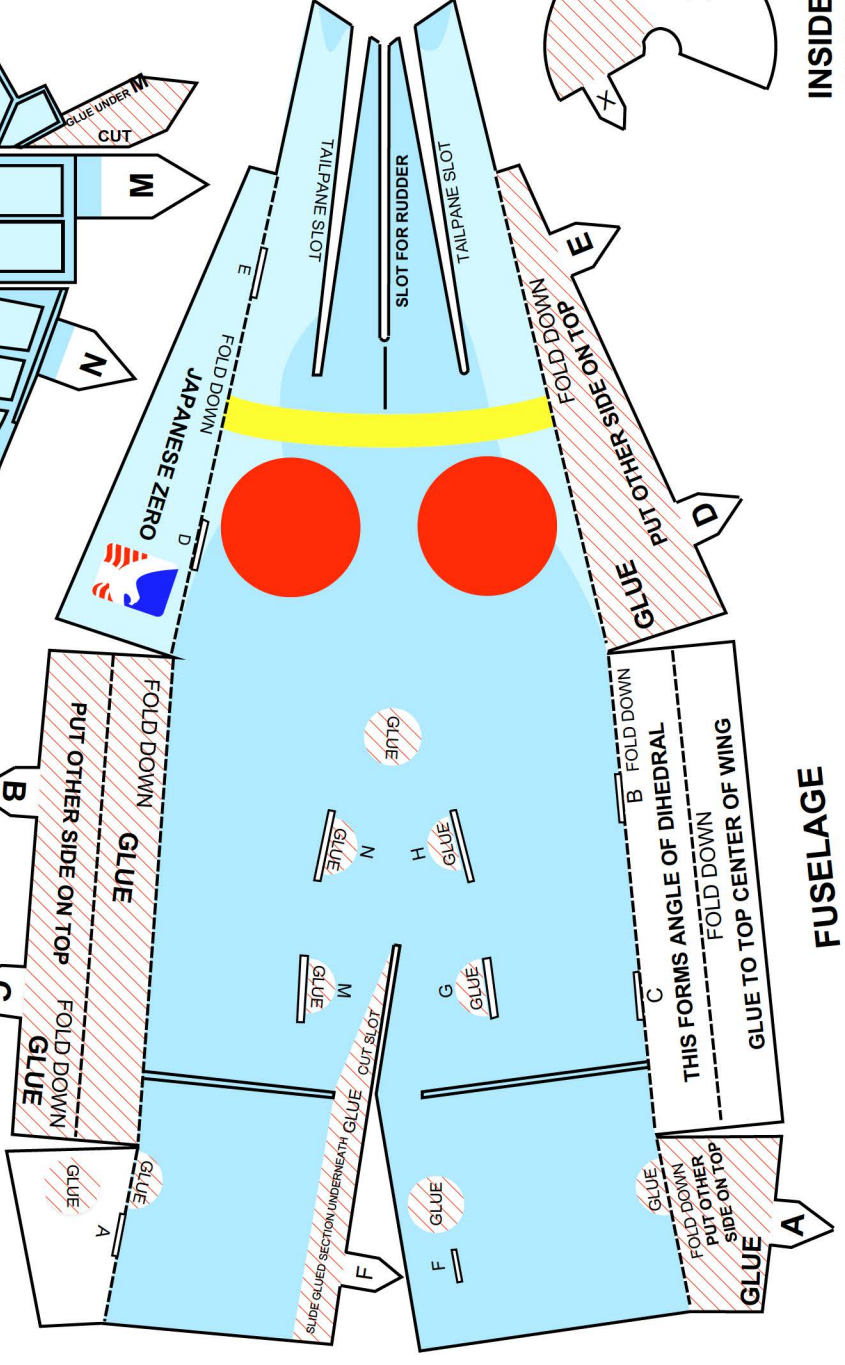

FUSELAGE

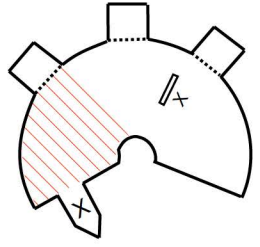

INSIDE CONE



COWL TRIM

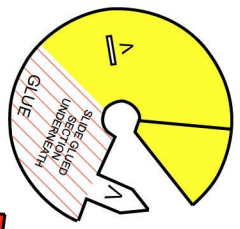

OUTSIDE CONE



WWII JAPANESE ZERO
CEREAL-BOX PENNY PLANE
Copyright © 1992 FLY'N THINGS™

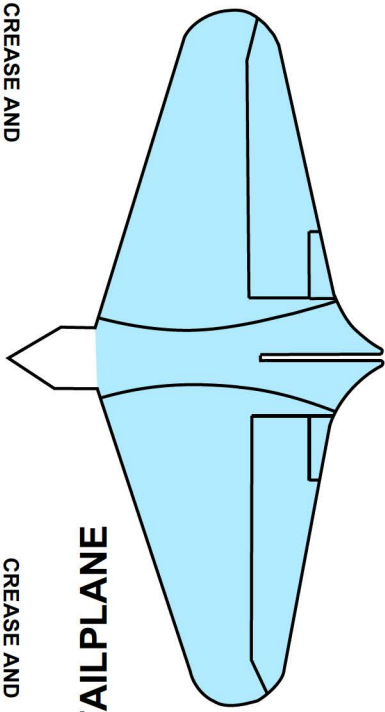

TAILPLANE

CREASE AND
FOLD UNDER

CREASE AND
FOLD UNDER

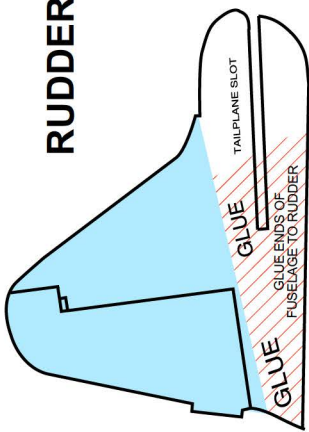
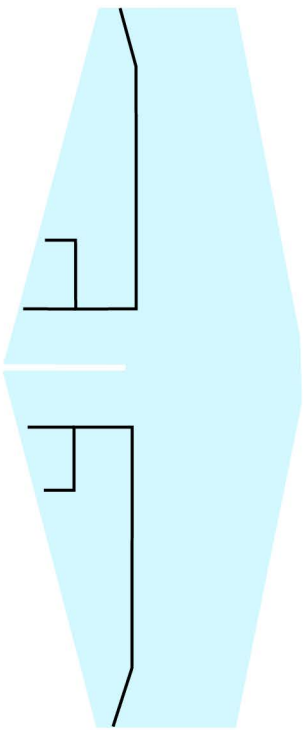

RUDDER

CREASE AND
FOLD UNDER

CREASE AND
FOLD UNDER

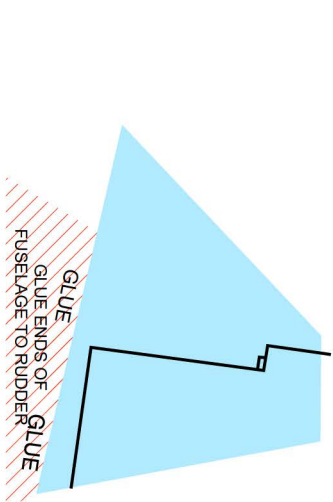

CREASE AND
FOLD UNDER

CREASE AND
FOLD UNDER

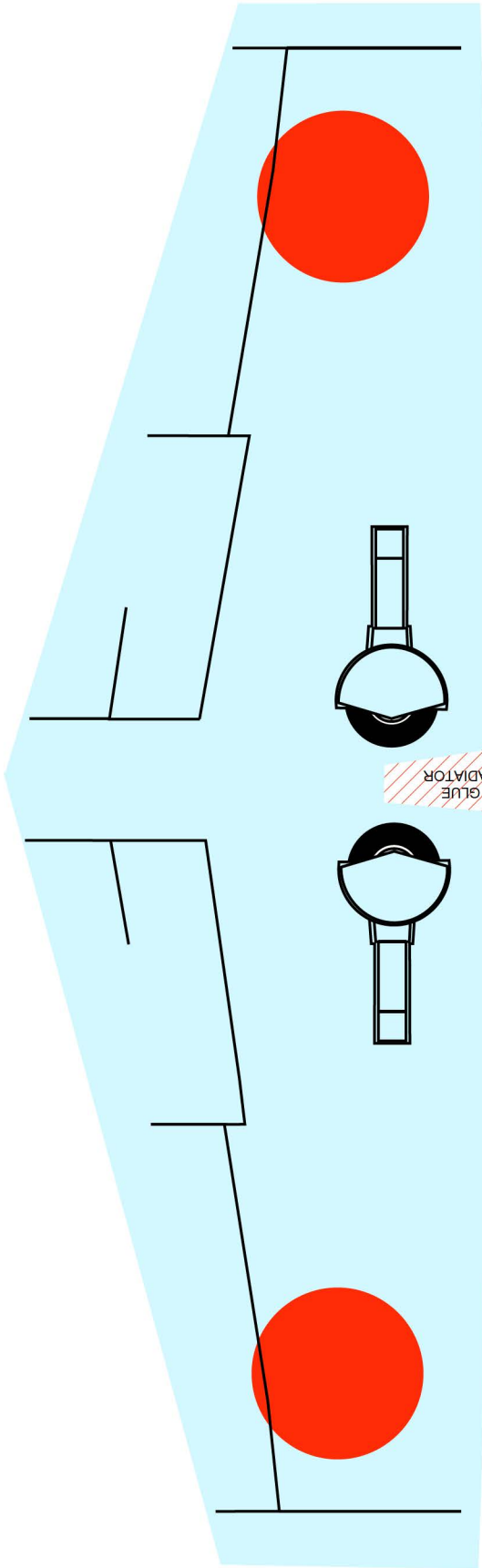

GLUE
RADIATOR

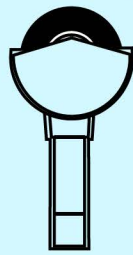
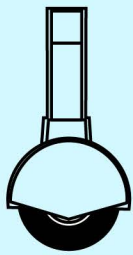

WING

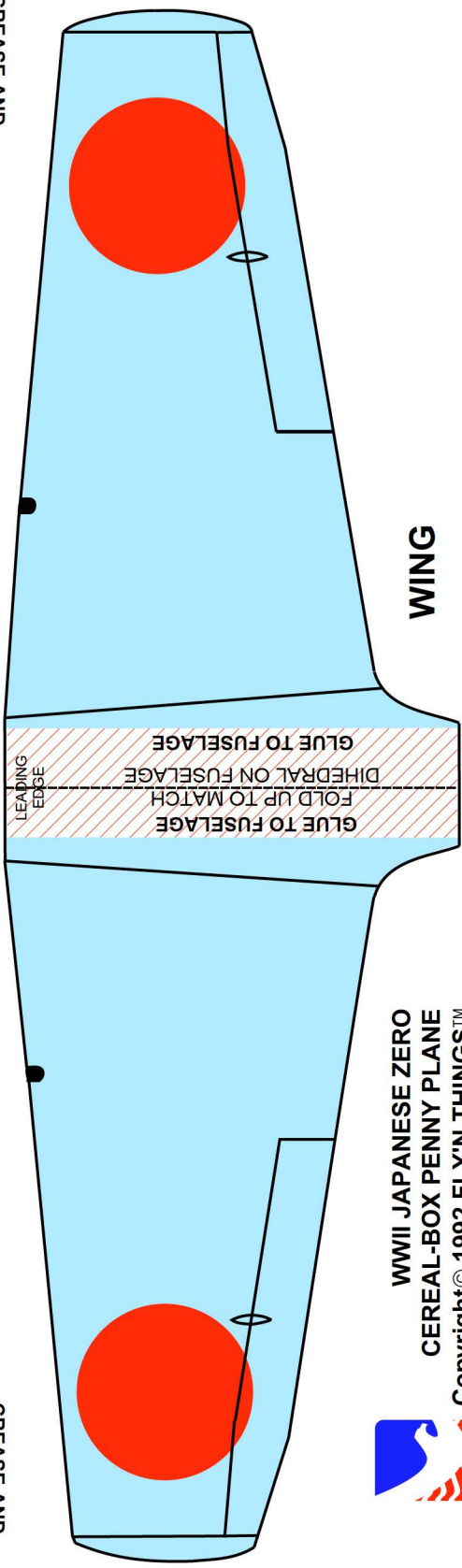



**WWII JAPANESE ZERO
CEREAL-BOX PENNY PLANE™**
Copyright © 1992 FLY'N THINGS™

RADIATOR



COCKPIT COVER

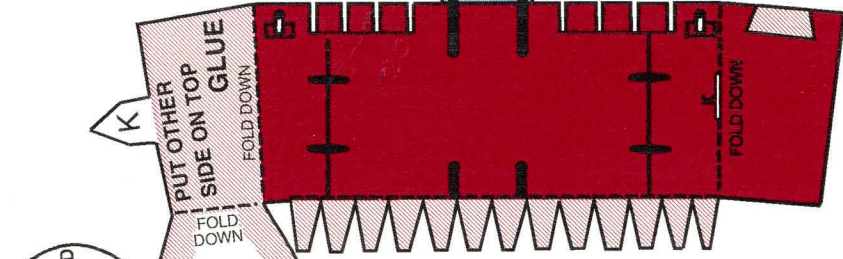
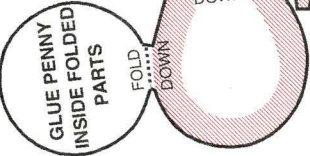
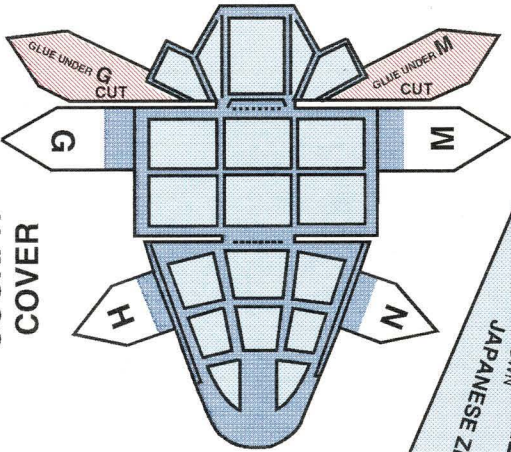

COWL

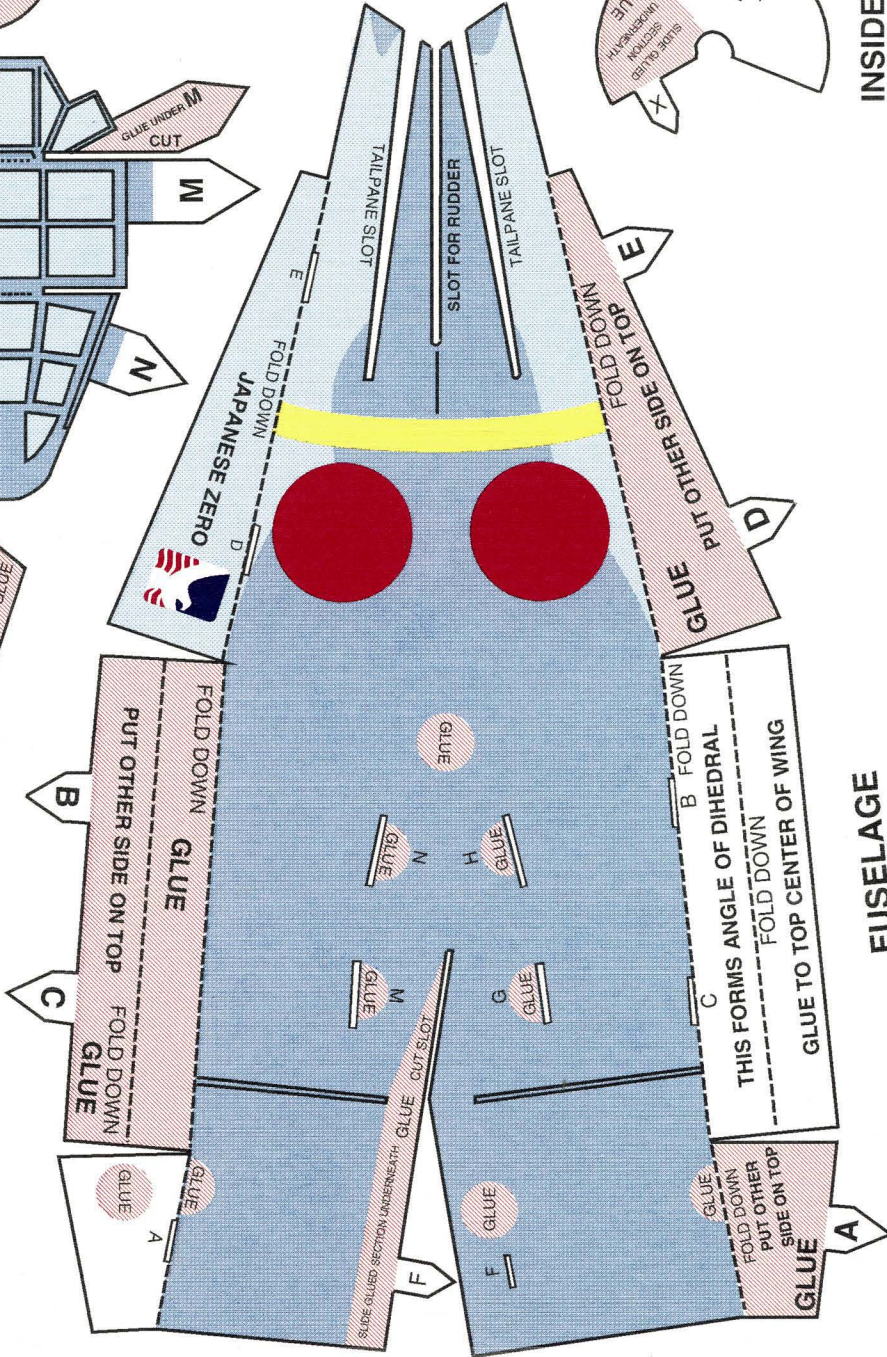

FUSELAGE

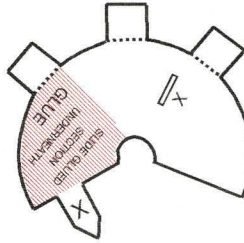

INSIDE CONE



COWL TRIM

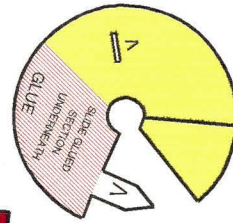

OUTSIDE CONE

THIS FORMS ANGLE OF DIHEDRAL
FOLD DOWN
GLUE TO TOP CENTER OF WING

SLIDE YELLOW SECTION UNDERNETH
GLUE CUT SLOT

FOLD DOWN
GLUE
PUT OTHER SIDE ON TOP
GLUE

FOLD DOWN
GLUE
PUT OTHER SIDE ON TOP
GLUE

FOLD DOWN
JAPANESE ZERO

TAILPLANE SLOT
SLOT FOR RUDDER
TAILPLANE SLOT

FOLD DOWN
GLUE PENNY
INSIDE FOLDED
PARTS

FOLD DOWN
GLUE
PUT OTHER
SIDE ON TOP
GLUE

FOLD DOWN
GLUE

FOLD DOWN
GLUE

FOLD DOWN
GLUE

FOLD DOWN
GLUE

CUT THIS
WHITE
DISK

FOLD DOWN
GLUE
PUT OTHER
SIDE ON TOP
GLUE

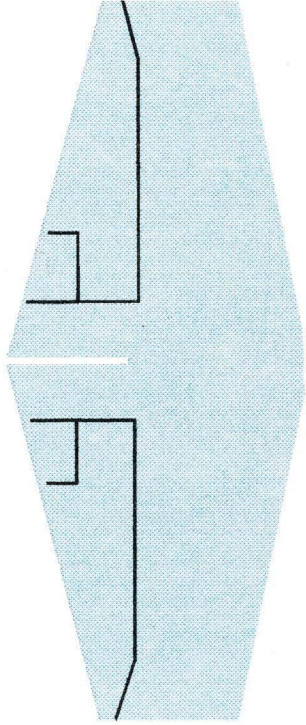

CREASE AND
FOLD UNDER

CREASE AND
FOLD UNDER

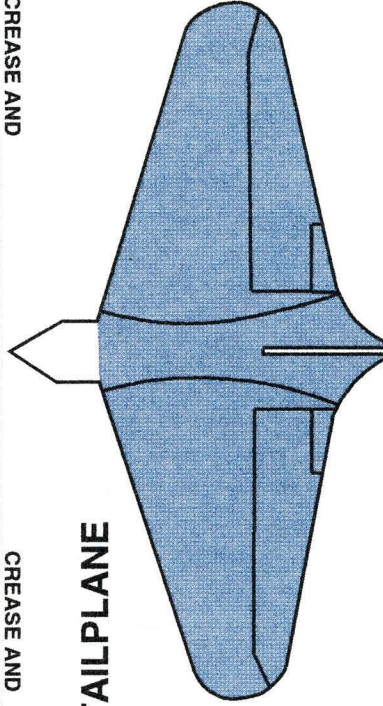

TAILPLANE

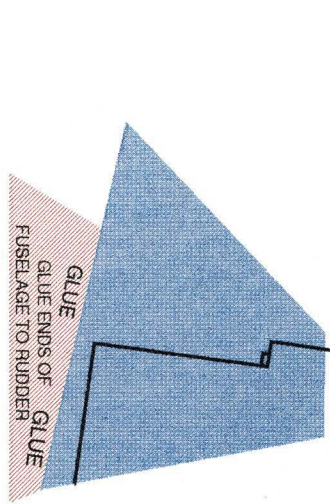

CREASE AND
FOLD UNDER

CREASE AND
FOLD UNDER

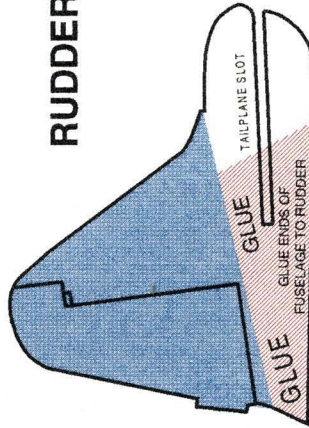

RUDDER



**WWII JAPANESE ZERO
CEREAL-BOX PENNY PLANE™
Copyright © 1992 FLY'N THINGS™**

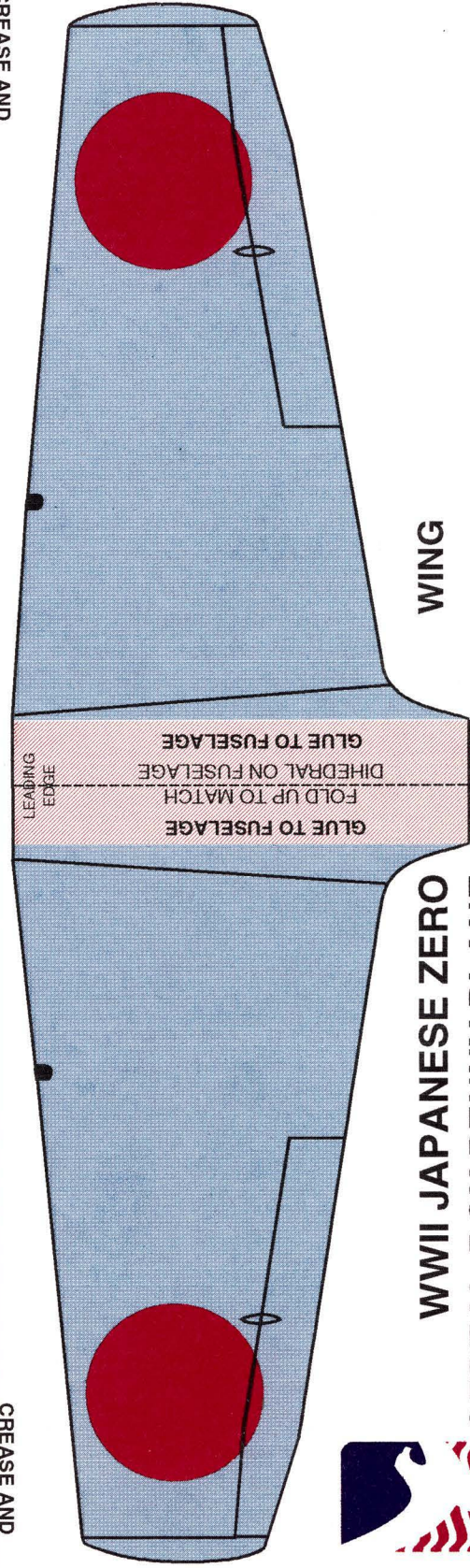
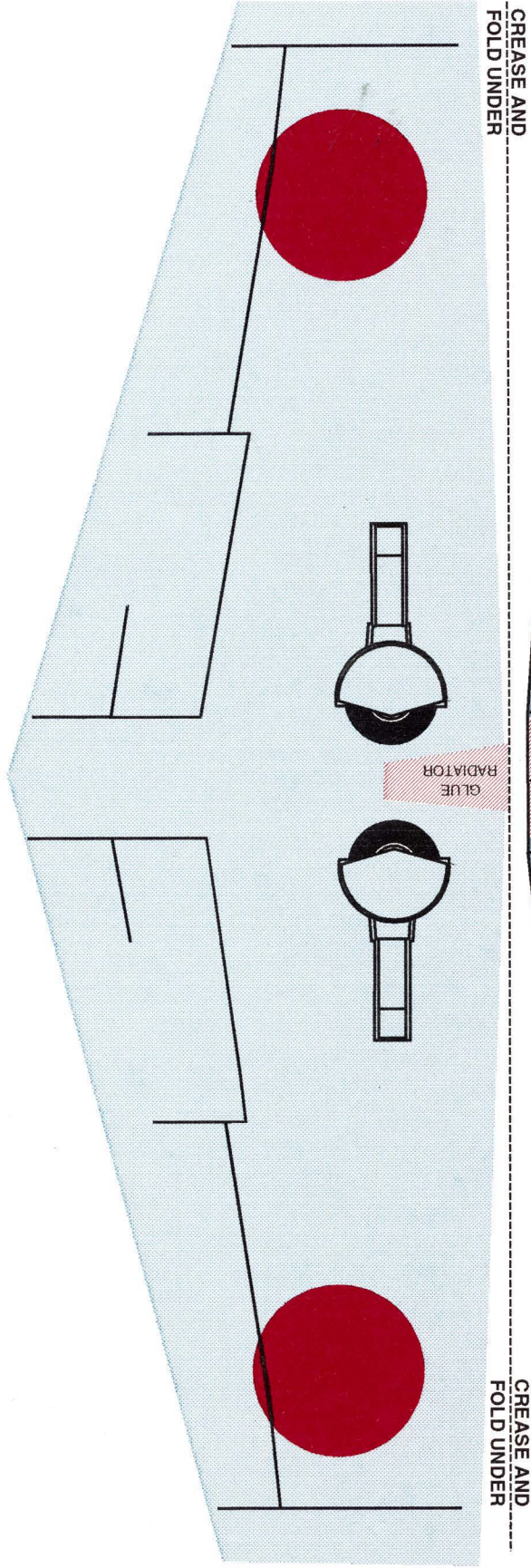

WWII JAPANESE ZERO
 CEREAL-BOX PENNY PLANE
 Copyright © 1992 FLY'N THINGS™

FUSELAGE

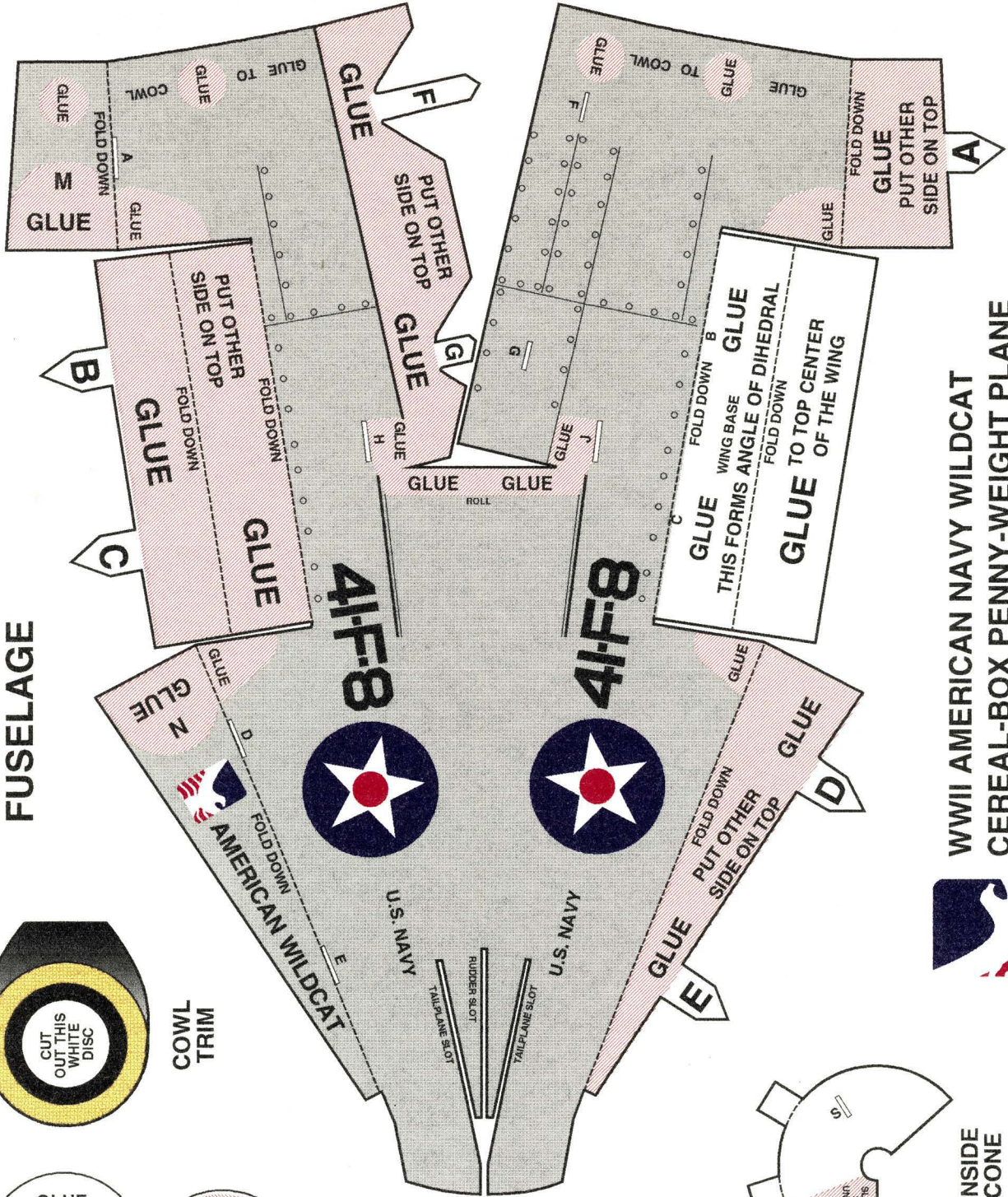

COWL TRIM

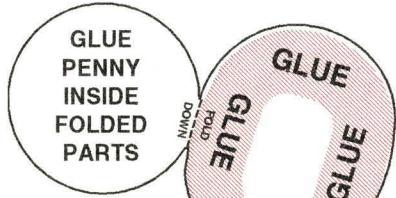

GLUE PENNY INSIDE FOLDED PARTS

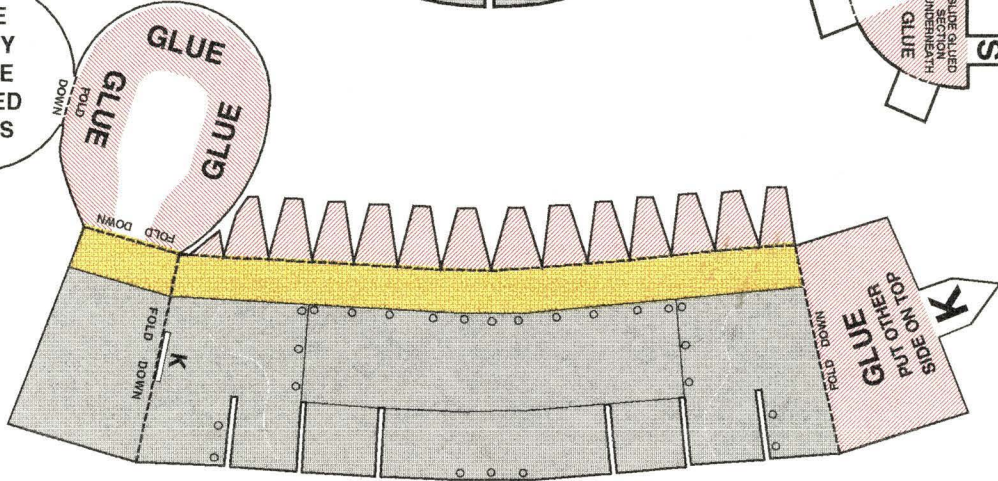

COWL

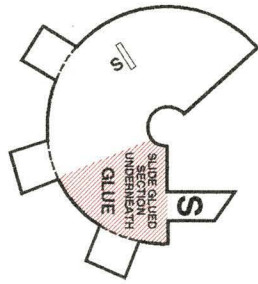

INSIDE CONE

**WWII AMERICAN NAVY WILDCAT
CEREAL-BOX PENNY-WEIGHT PLANE™
Copyright © 1993 FLY'N THINGS™**



BELLY SECTION

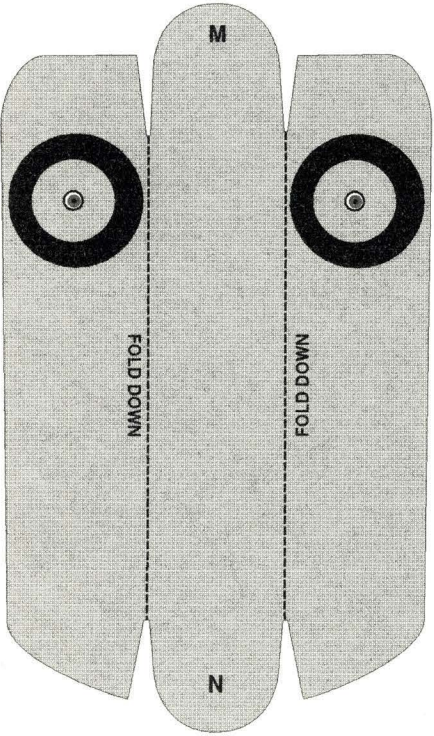

OUTSIDE CONE

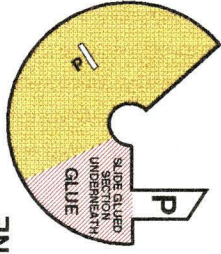

COCKPIT COVER

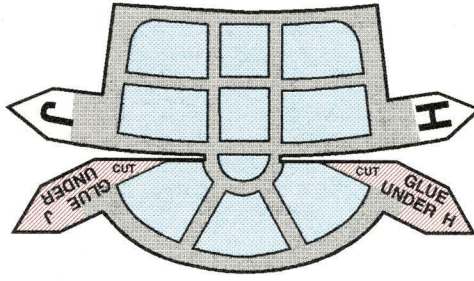

TAILPLANE

CREASE AND FOLD UNDER

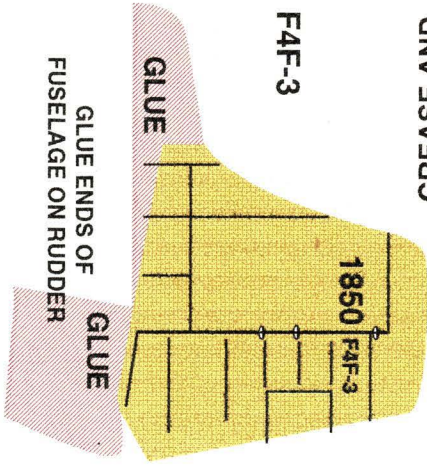
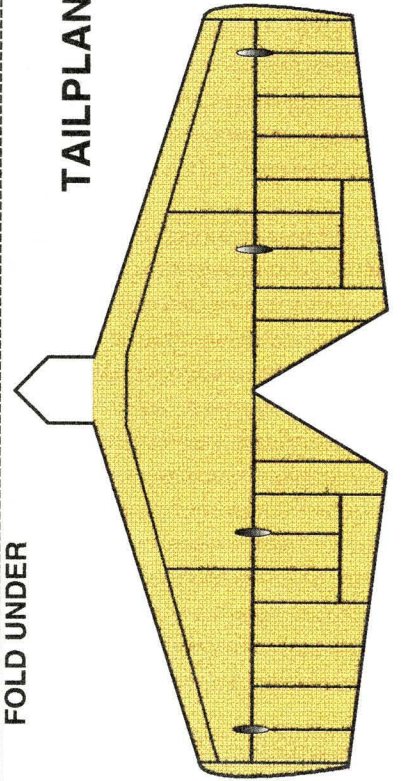

CREASE AND FOLD UNDER

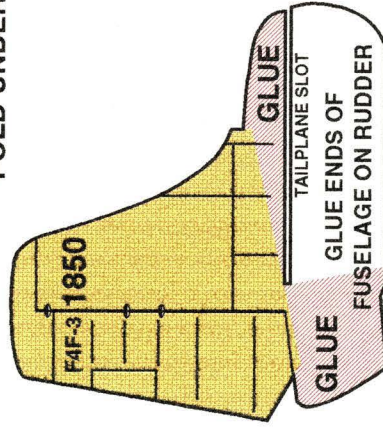

RUDDER



WWII AMERICAN NAVY WILDCAT
 CEREAL-BOX PENNY-WEIGHT PLANE
 Copyright © 1993 FLY'N THINGS™

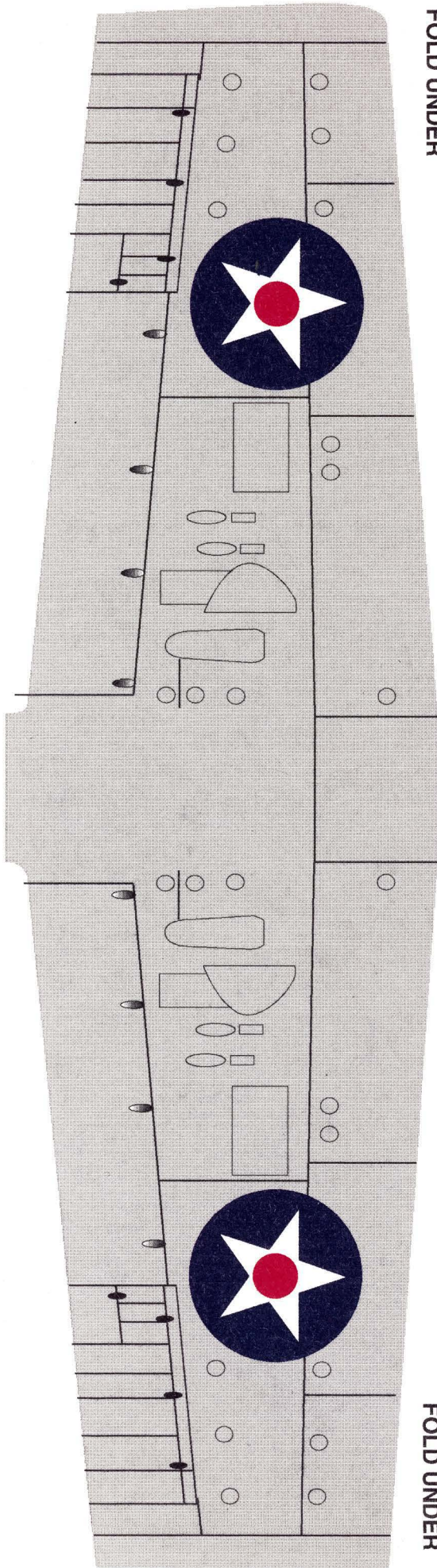

CREASE AND
FOLD UNDER

CREASE AND
FOLD UNDER

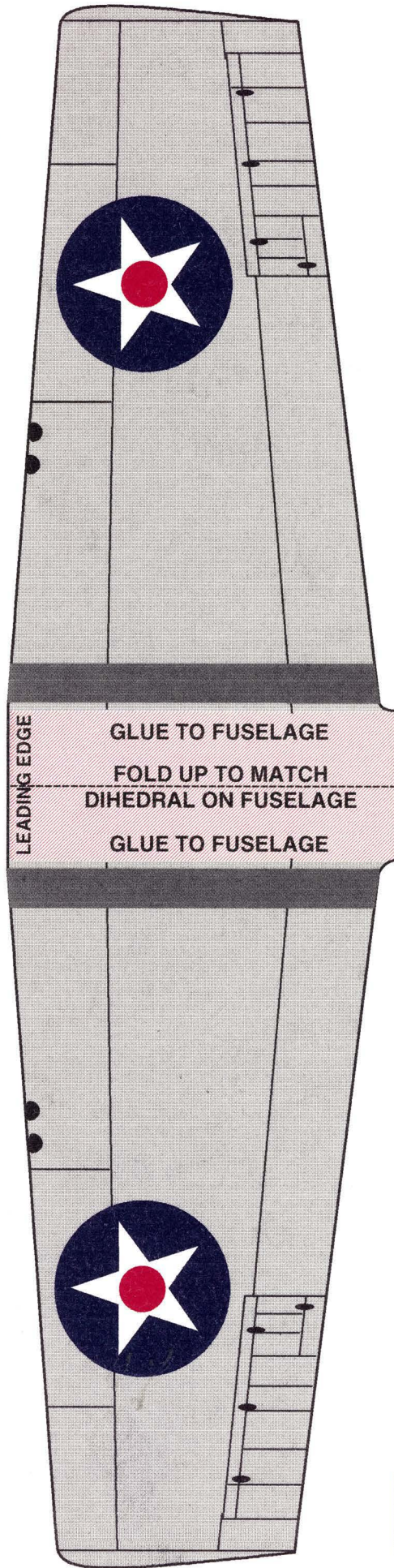

WING

WWII AMERICAN NAVY WILDCAT
CEREAL-BOX PENNY-WEIGHT PLANE
Copyright © 1993 FLY'N THINGS™

FUSELAGE

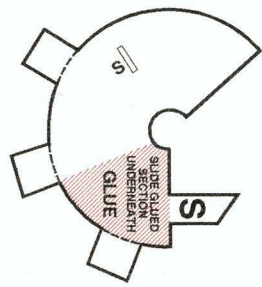
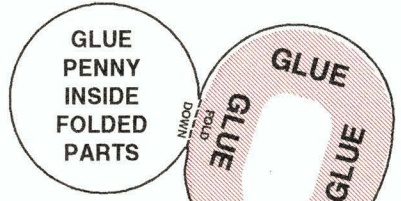
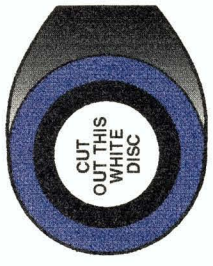
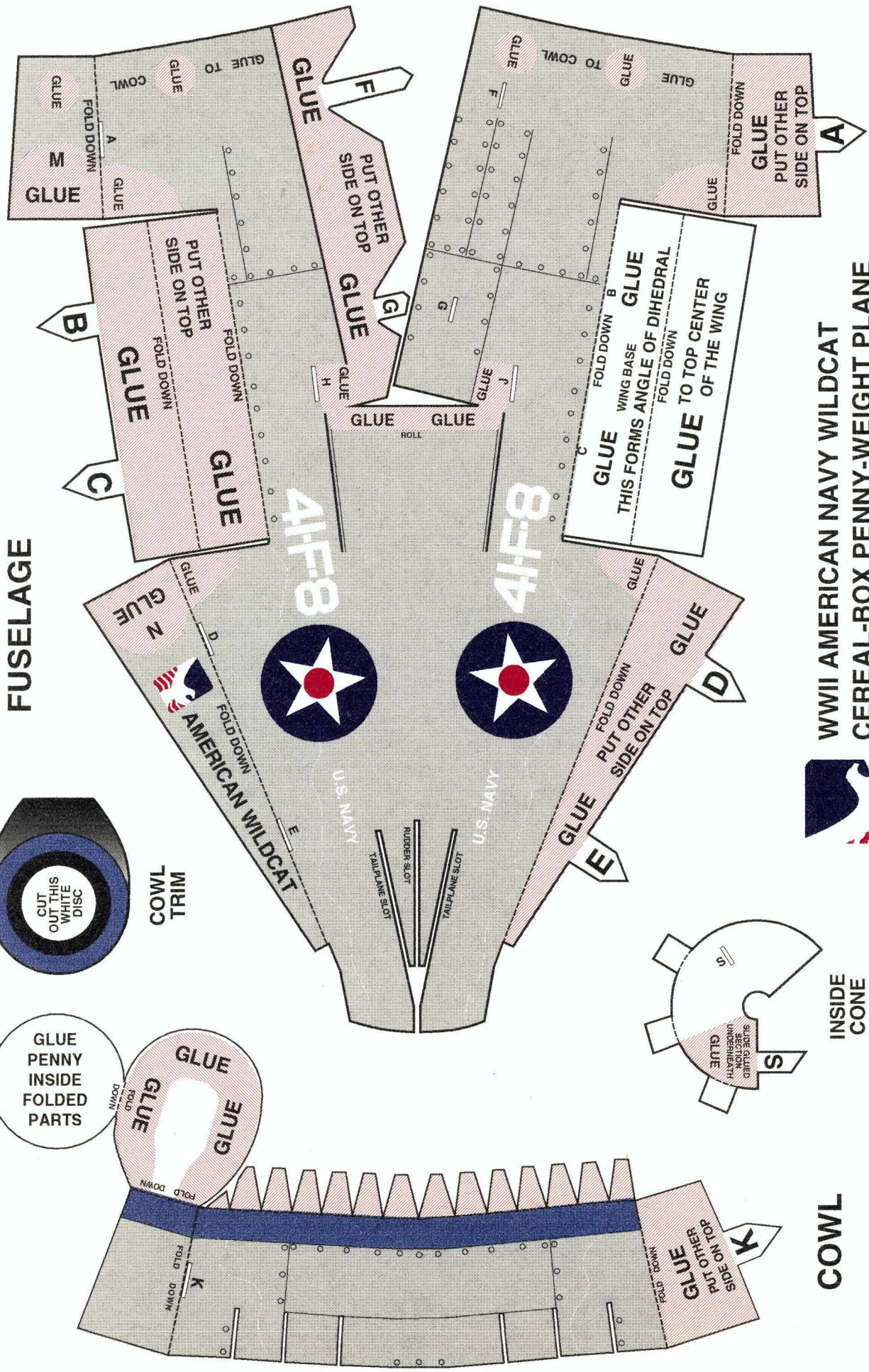

**WWII AMERICAN NAVY WILDCAT
CEREAL-BOX PENNY-WEIGHT PLANE**
Copyright © 1993 FLY'N THINGS™

COWL

BELLY SECTION

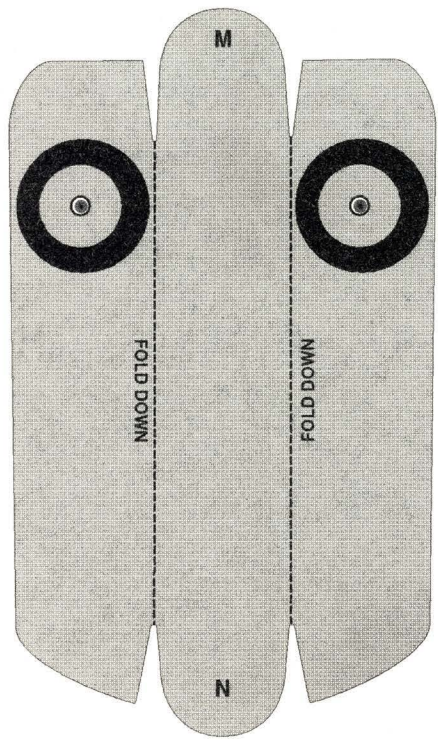

OUTSIDE CONE

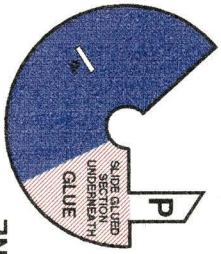

COCKPIT COVER

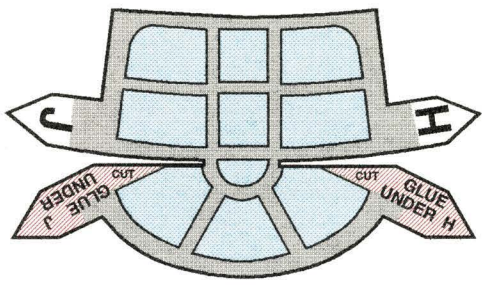

TAILPLANE

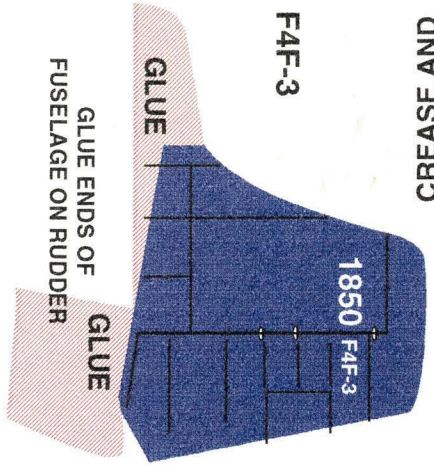
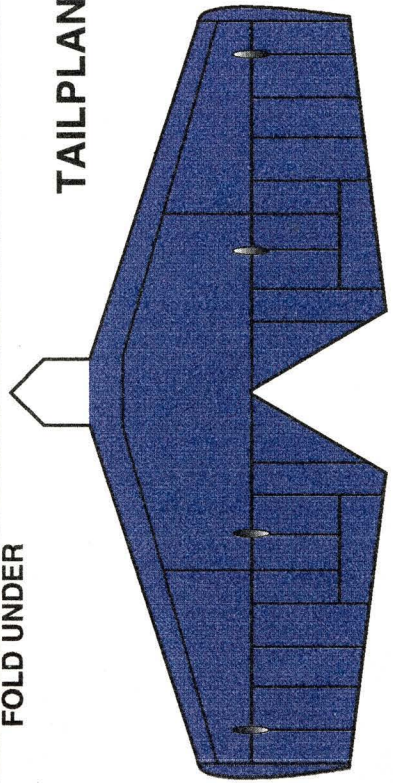

CREASE AND FOLD UNDER

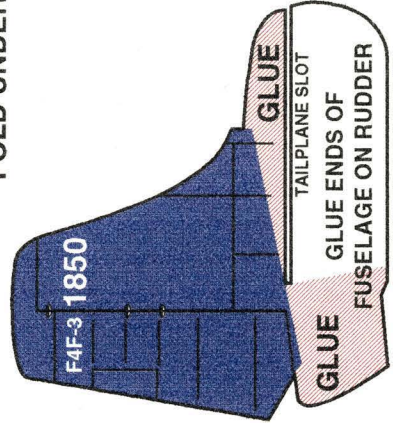

RUDDER



WWII AMERICAN NAVY WILDCAT
 CEREAL-BOX PENNY-WEIGHT PLANE
 Copyright © 1993 FLY'N THINGS™

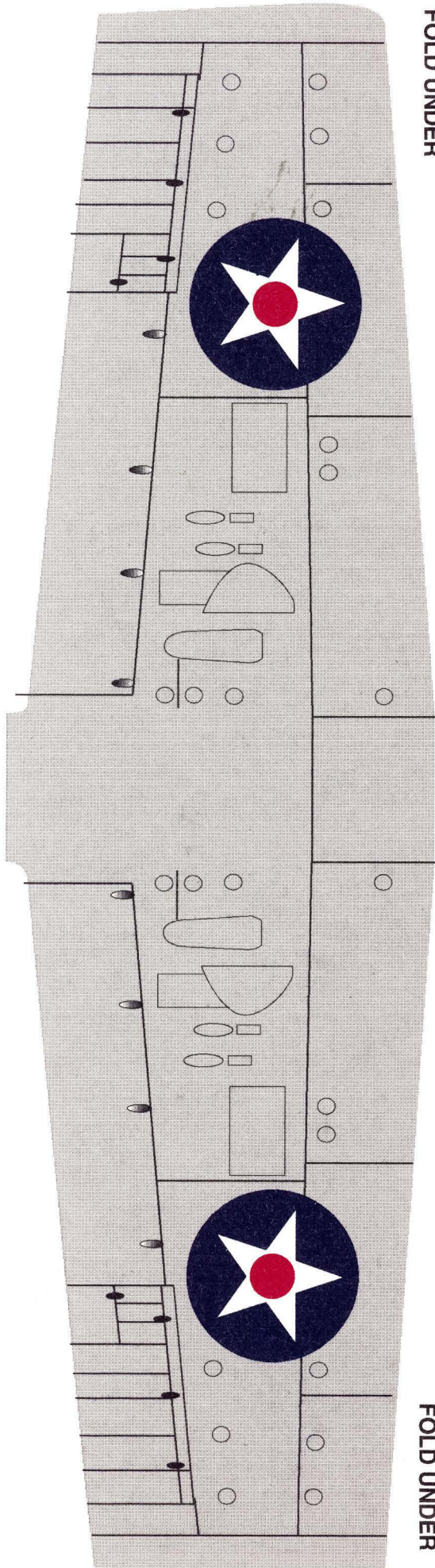

CREASE AND
FOLD UNDER

CREASE AND
FOLD UNDER

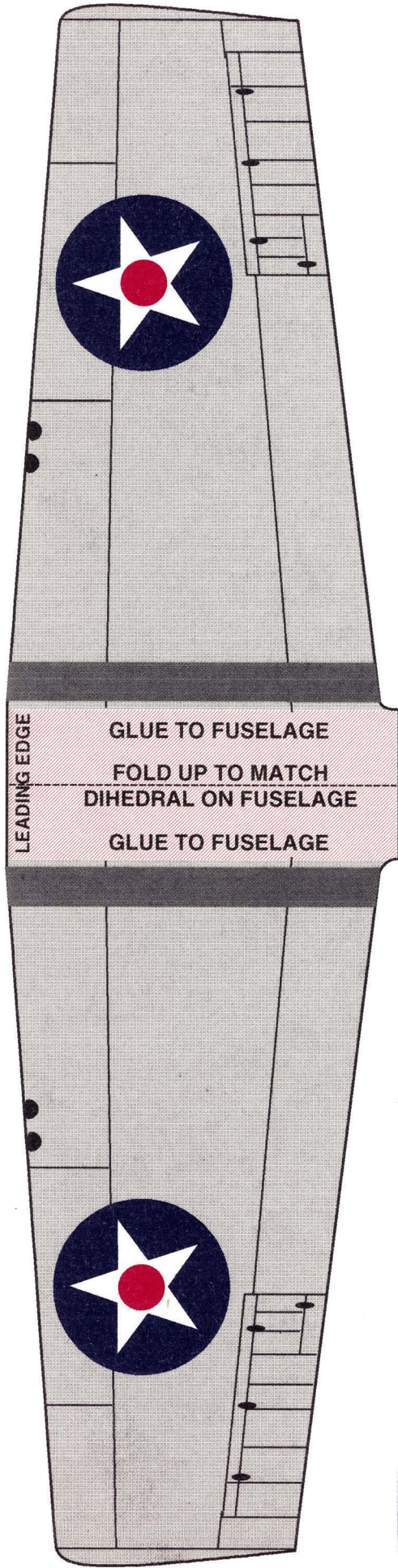

WING

**WWII AMERICAN NAVY WILDCAT
CEREAL-BOX PENNY-WEIGHT PLANE**
Copyright © 1993 FLY'N THINGS™





COWL TRIM

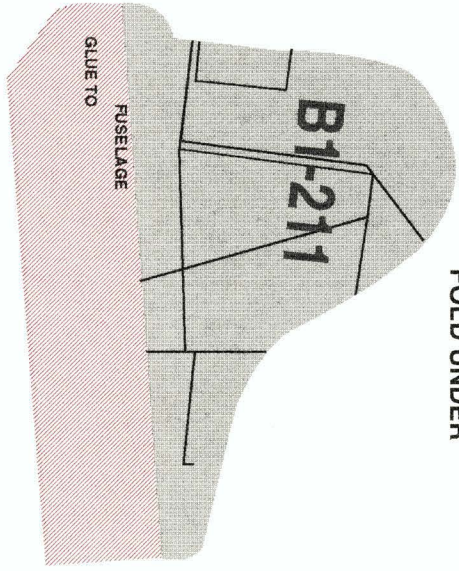

CREASE AND FOLD UNDER

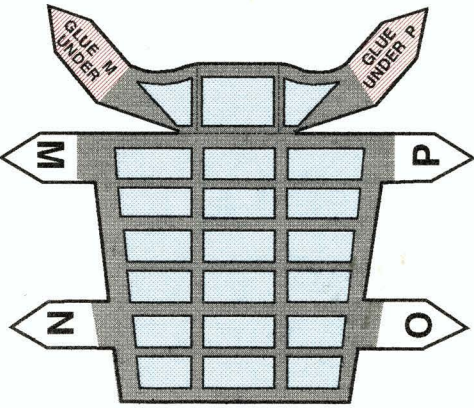

COCKPIT COVER

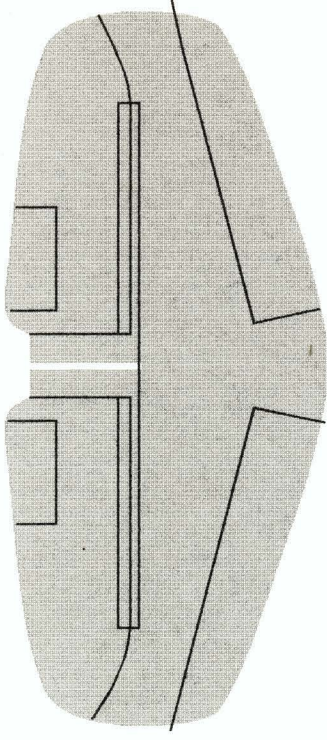

CREASE AND FOLD UNDER

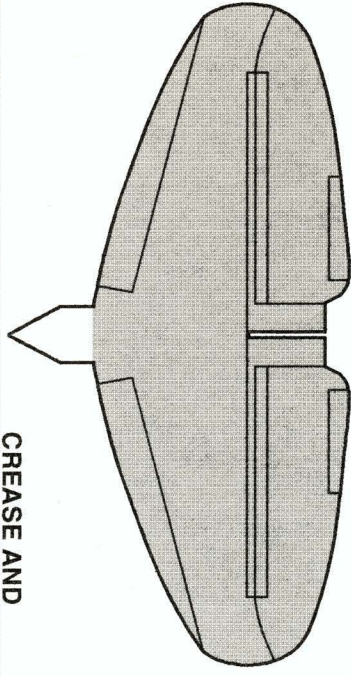

RUDDER

TAIL PLANE



WWII JAPANESE AICHI "VAL" T99-2
CEREAL-BOX PENNY-WEIGHT PLANE
Copyright © 1993 FLY'N THINGS™

LANDING GEAR

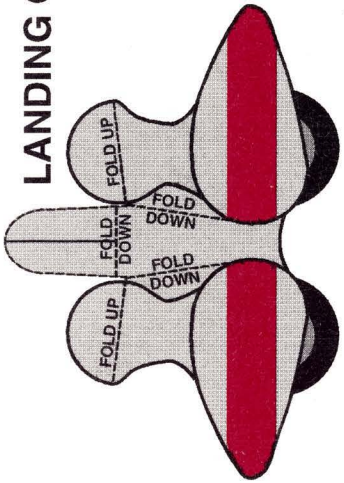

LANDING GEAR

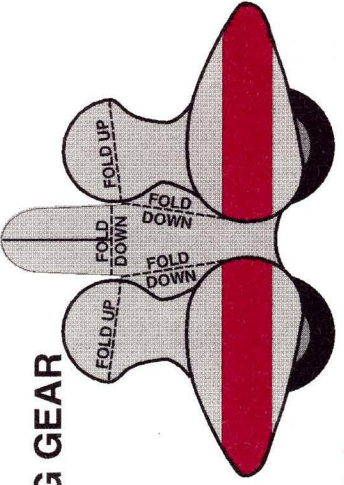

WWII JAPANESE AICHI "VAL" T99-2
CEREAL-BOX PENNY-WEIGHT PLANE
Copyright © 1993 FLY'N THINGS™

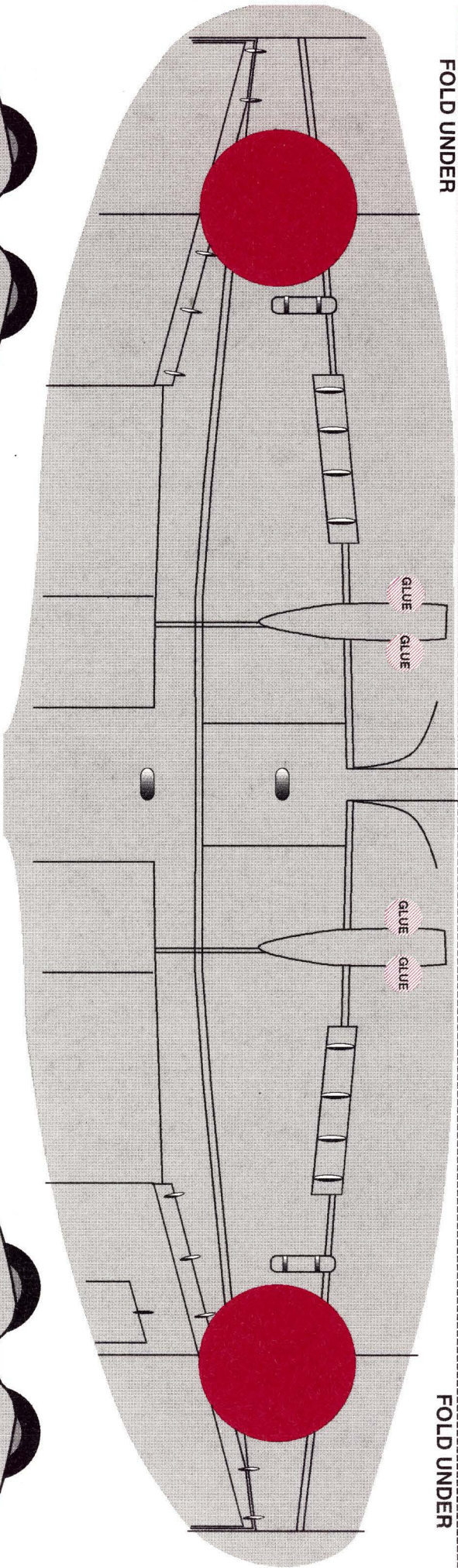

CREASE AND
FOLD UNDER

CREASE AND
FOLD UNDER

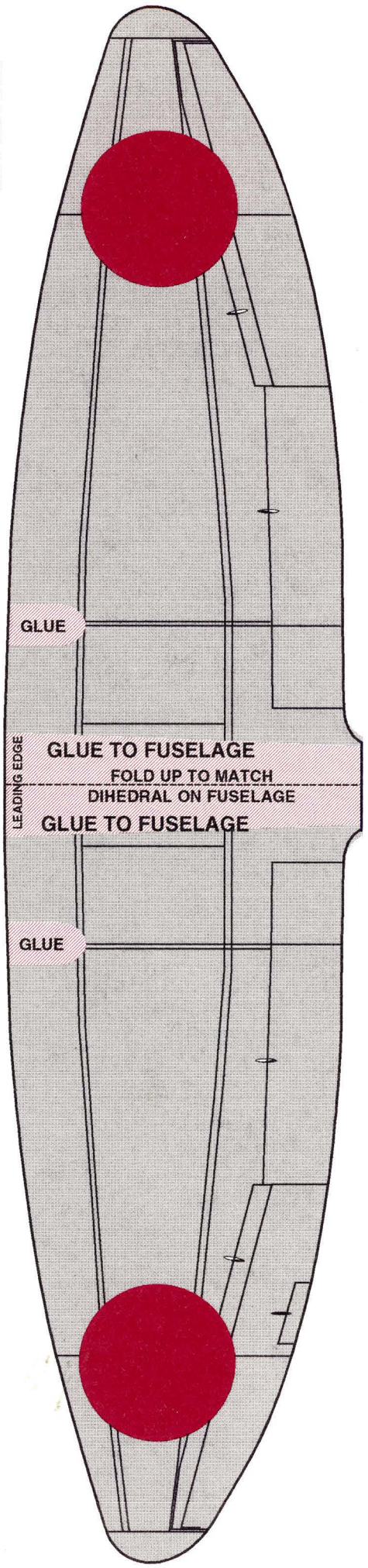

WING

GLUE TO FUSELAGE
FOLD UP TO MATCH
DIHEDRAL ON FUSELAGE
GLUE TO FUSELAGE

GLUE

GLUE

GLUE GLUE

GLUE GLUE

LEADING EDGE

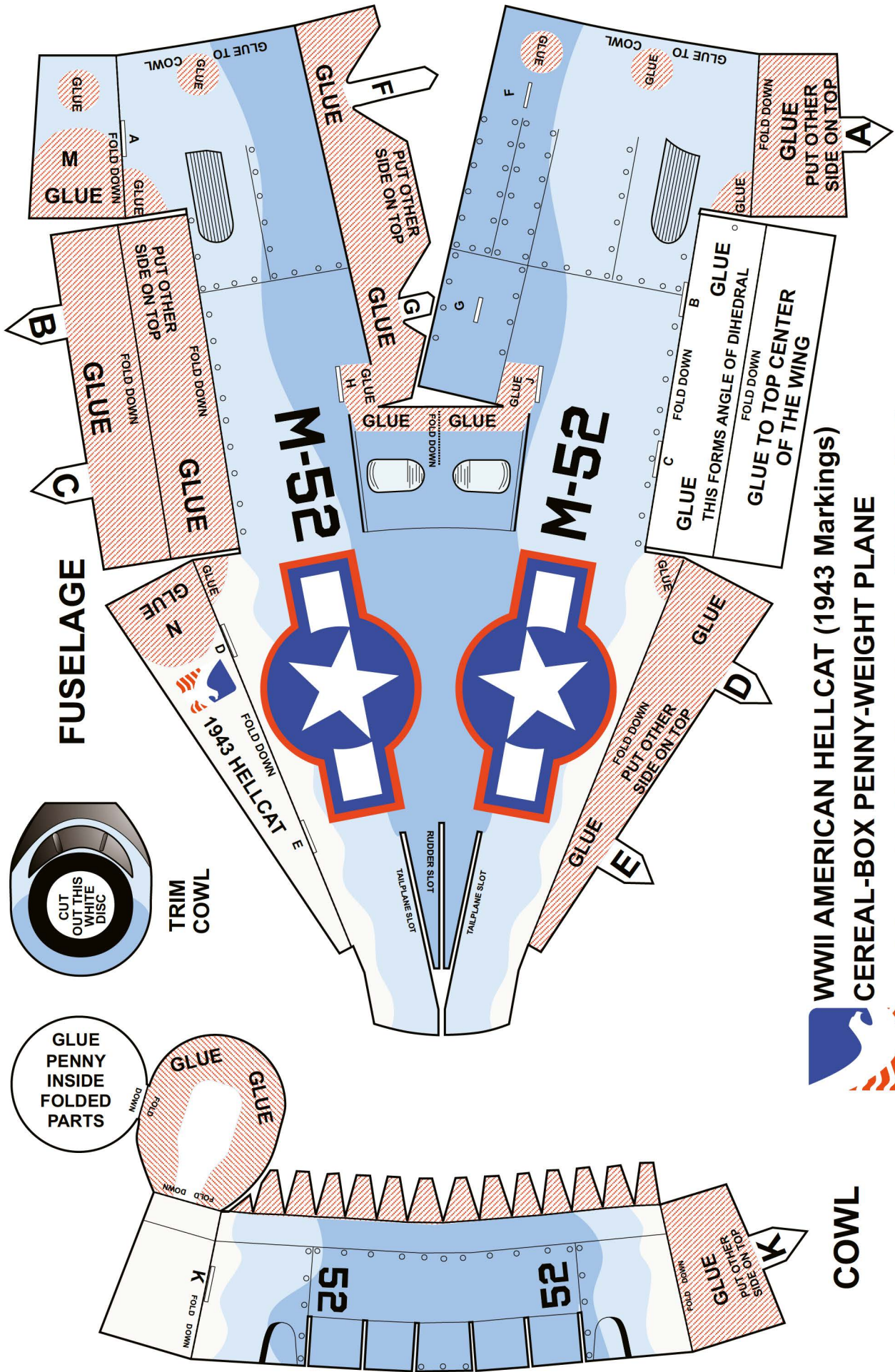

FUSELAGE

M-52

M-52

TRIM COWL

GLUE PENNY INSIDE FOLDED PARTS

WWII AMERICAN HELLCAT (1943 Markings)
CEREAL-BOX PENNY-WEIGHT PLANE

COWL

Copyright • 1993 FLY'N THINGS® (SHEET 1 OF 3)

BELLY SECTION

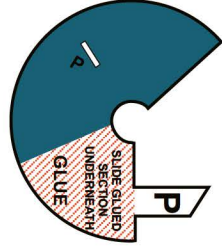
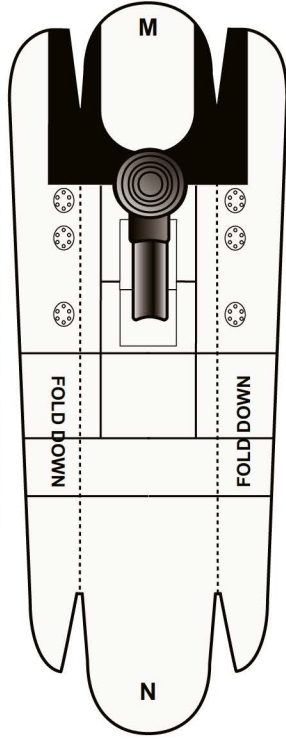

OUTSIDE
CONE

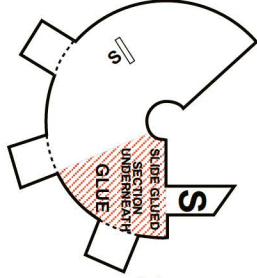

INSIDE
CONE

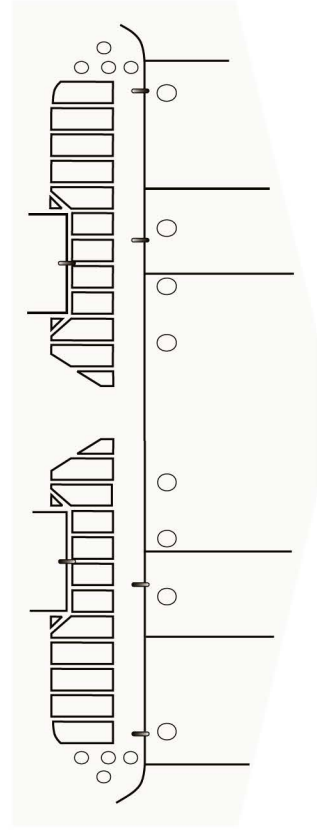

FOLD UNDER
CREASE AND

TAILPLANE

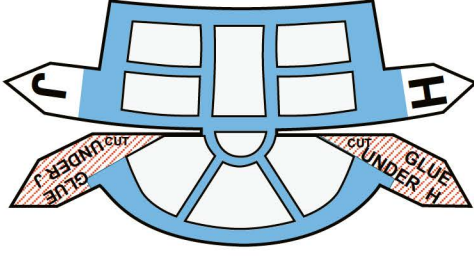

COCKPIT
COVER

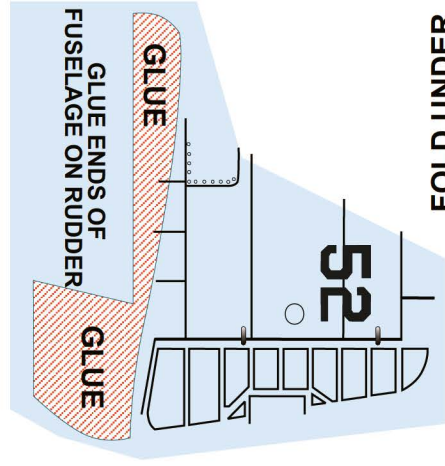

FOLD UNDER
CREASE AND

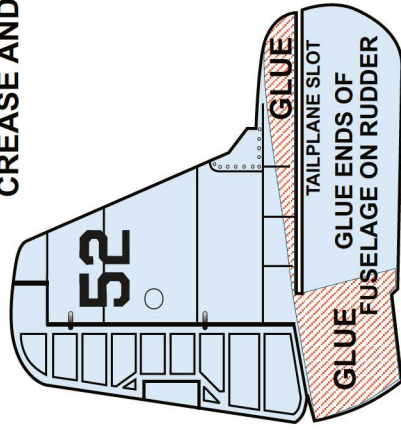

RUDDER



WWII AMERICAN HELLCAT (1943 Markings)
CEREAL-BOX PENNY-WEIGHT PLANE

Copyright • 1993 FLY'N THINGS® (SHEET 2 OF 3)

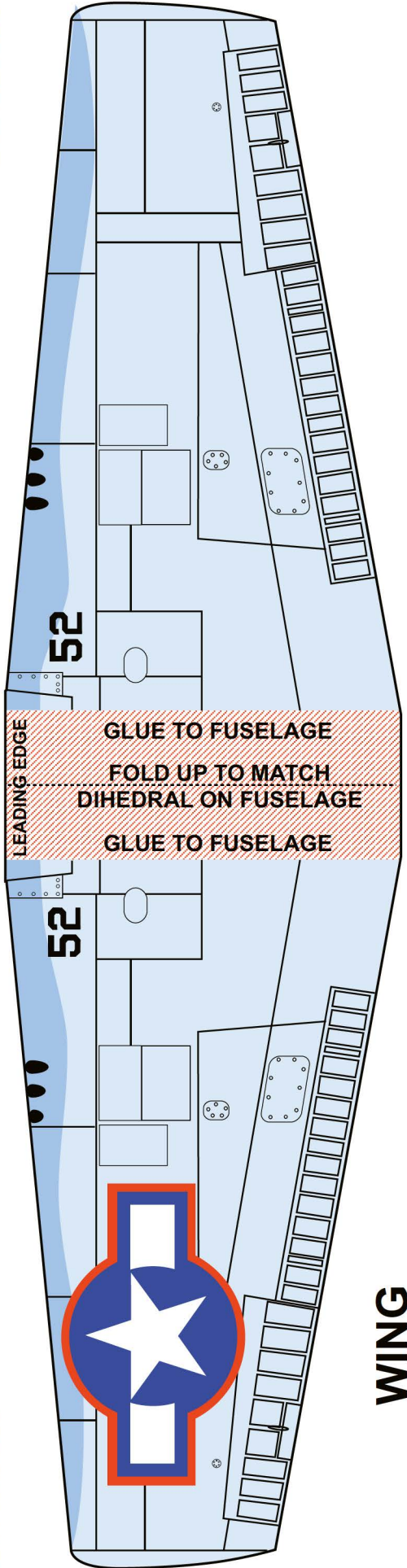
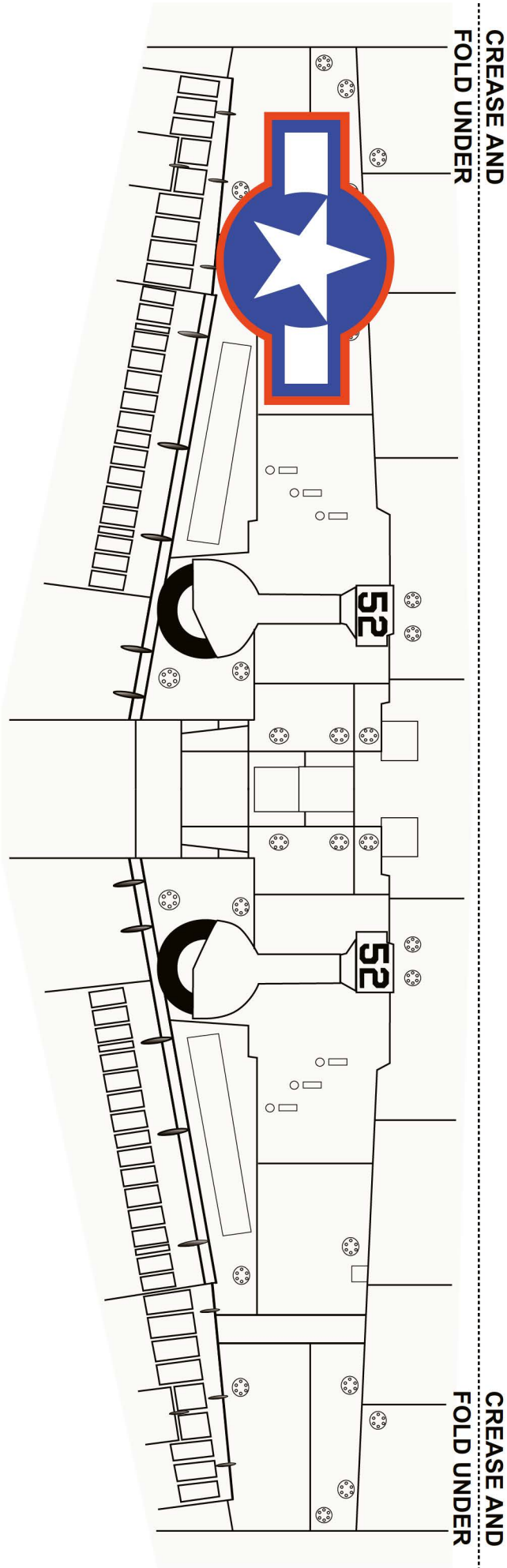

WWII AMERICAN HELLCAT (1943 Markings)
 CEREAL-BOX PENNY-WEIGHT PLANE

Copyright • 1993 FLY'N THINGS® (SHEET 3 OF 3)

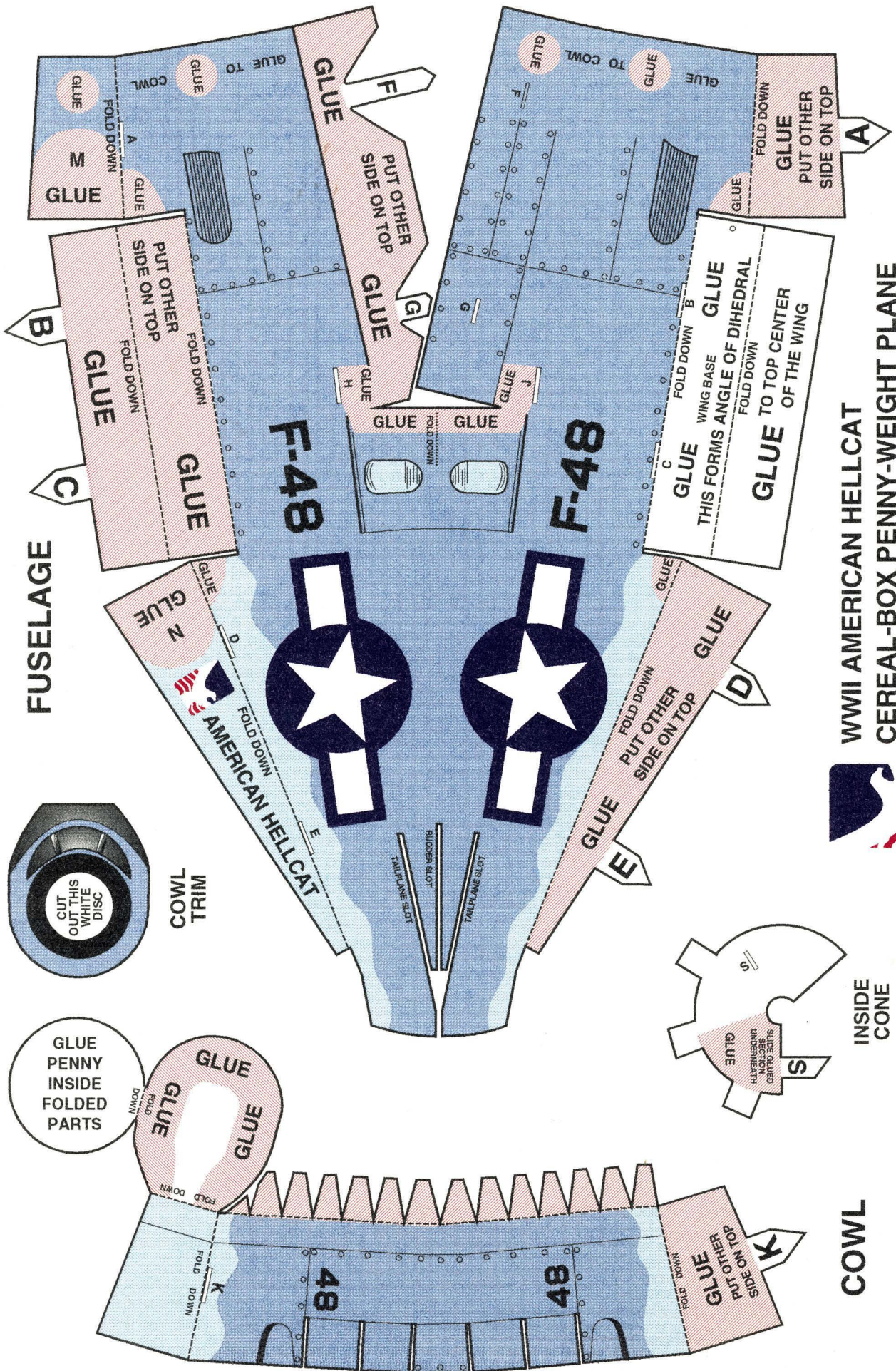

FUSELAGE

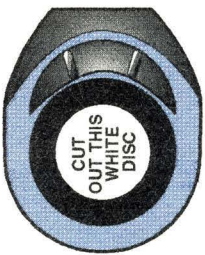

COWL TRIM

GLUE PENNY INSIDE FOLDED PARTS

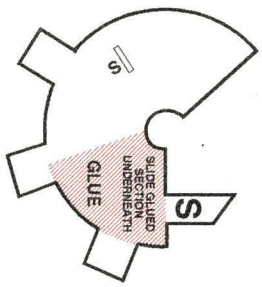
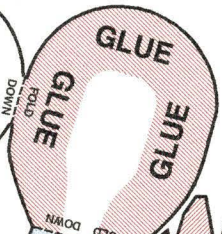

INSIDE CONE

COWL

WWII AMERICAN HELLCAT
 CEREAL-BOX PENNY-WEIGHT PLANE
 Copyright © 1993 FLY'N THINGS™



BELLY SECTION

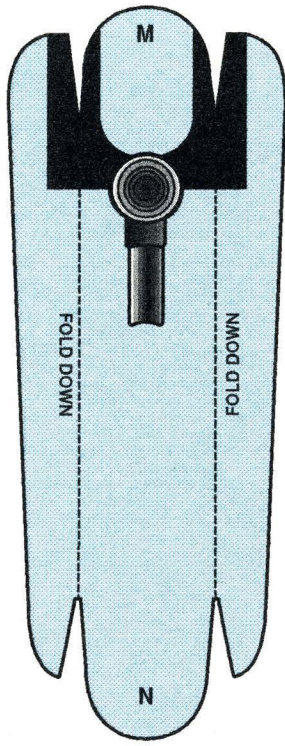

OUTSIDE CONE

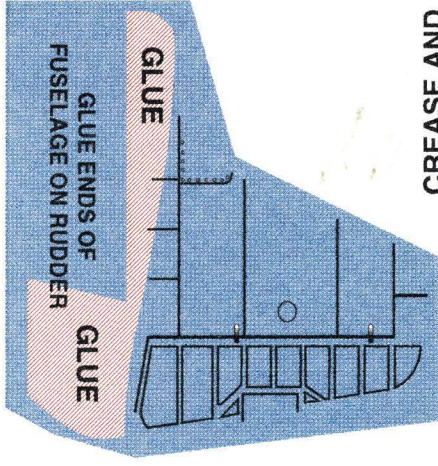
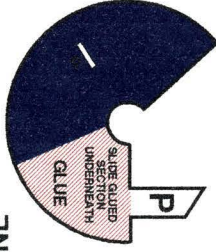

CREASE AND FOLD UNDER

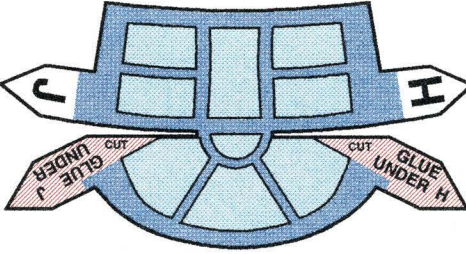

COCKPIT COVER

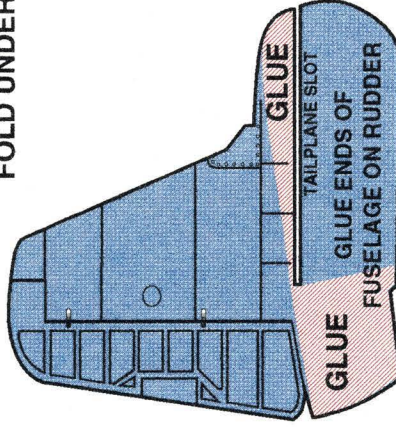

RUDDER

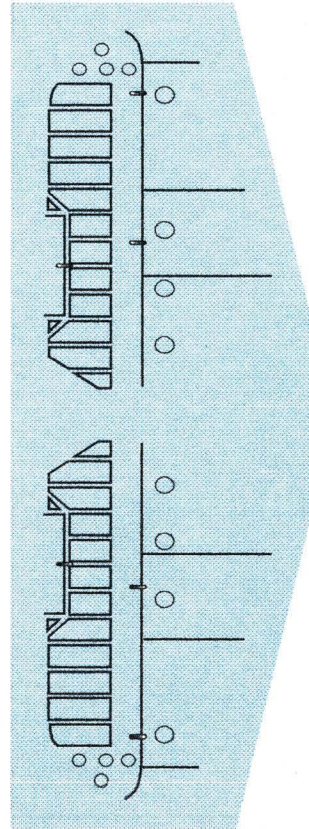

CREASE AND FOLD UNDER

TAILPLANE

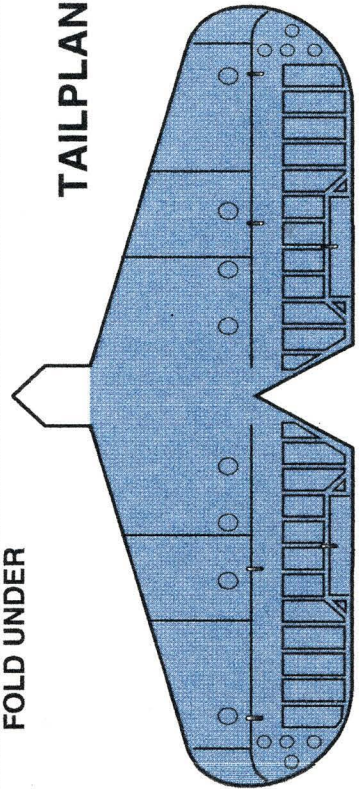

WWI AMERICAN HELLCAT
 CEREAL-BOX PENNY-WEIGHT PLANE
 Copyright © 1993 FLY'N THINGS™

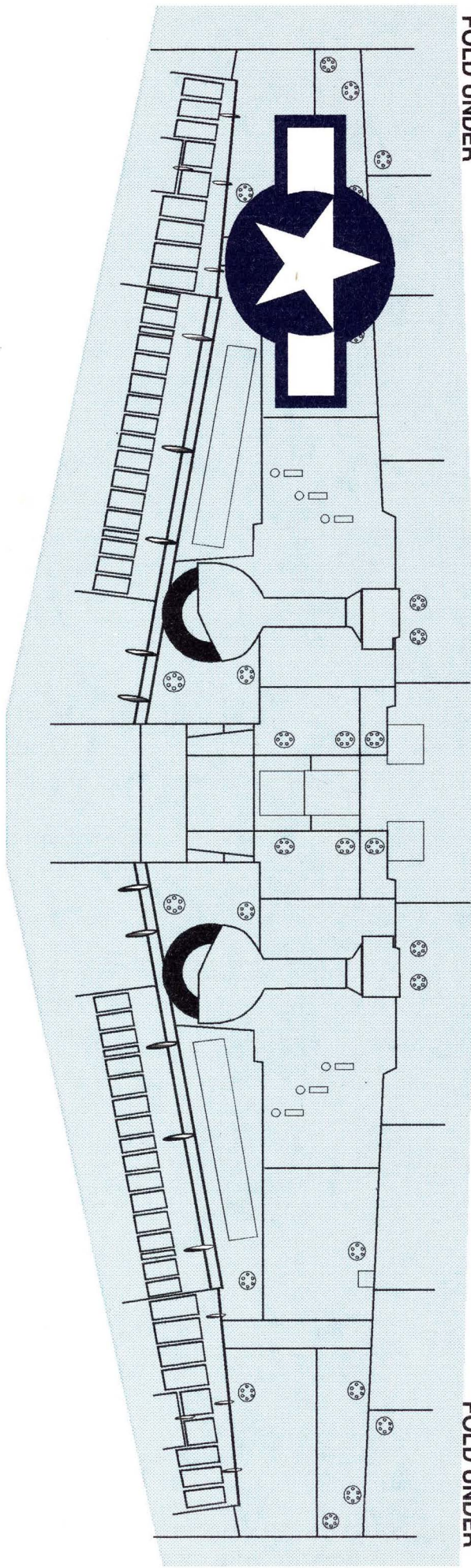

CREASE AND
FOLD UNDER

CREASE AND
FOLD UNDER

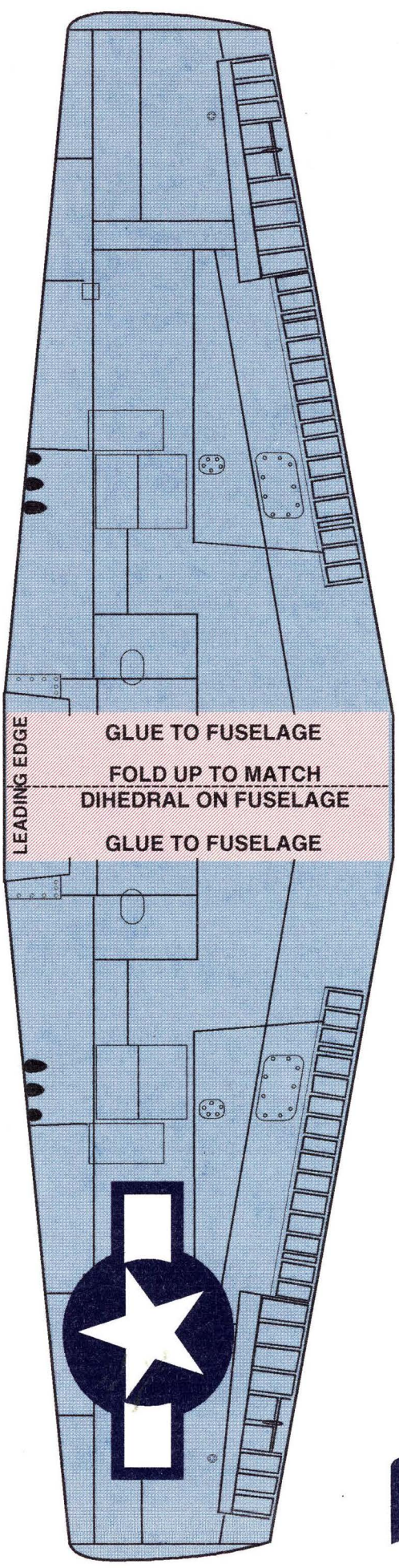

LEADING EDGE

GLUE TO FUSELAGE
FOLD UP TO MATCH
DIHEDRAL ON FUSELAGE
GLUE TO FUSELAGE

WING

WWII AMERICAN HELLCAT
CEREAL-BOX PENNY-WEIGHT PLANE
Copyright © 1993 FLY'N THINGS™



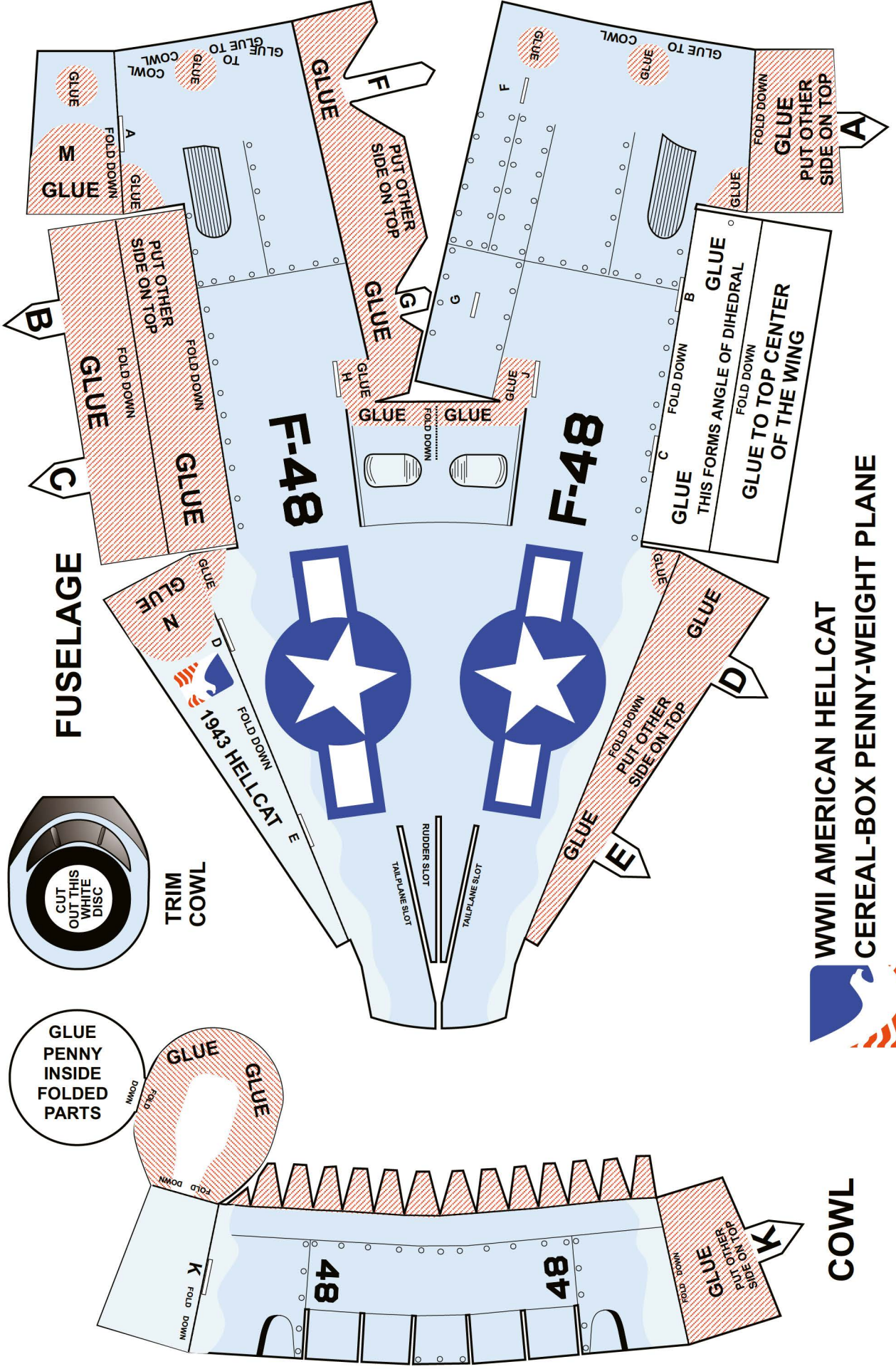

FUSELAGE

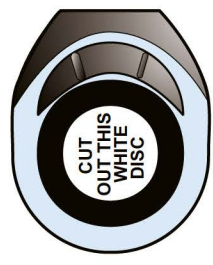

TRIM COWL

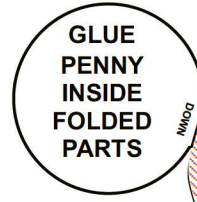

**WWII AMERICAN HELLCAT
CEREAL-BOX PENNY-WEIGHT PLANE**

COWL

BELLY SECTION

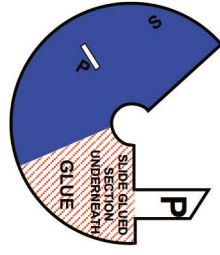
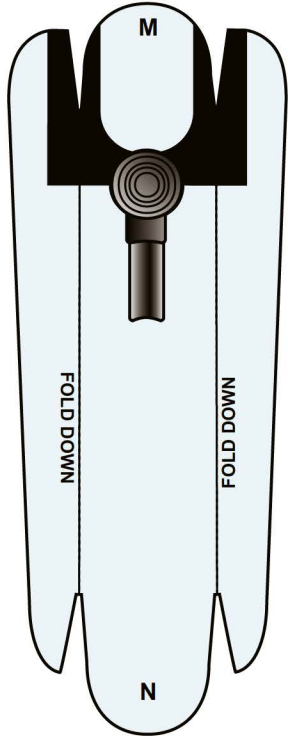

OUTSIDE CONE

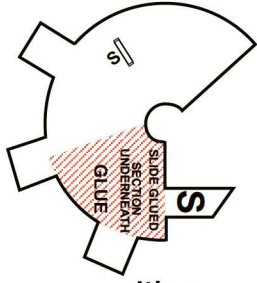

INSIDE CONE

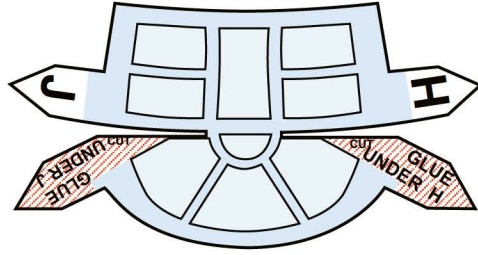

COCKPIT COVER

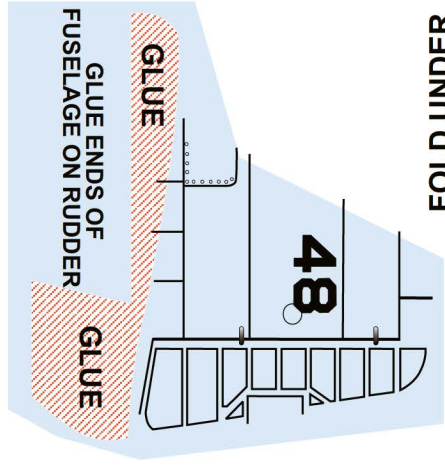

FOLD UNDER
CREASE AND

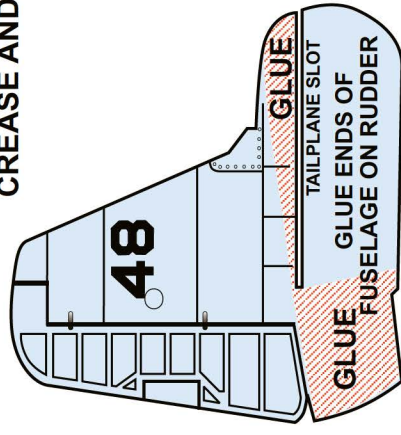

RUDDER

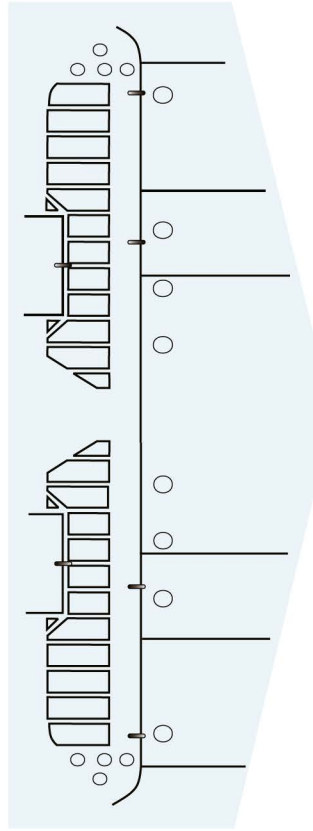

FOLD UNDER
CREASE AND

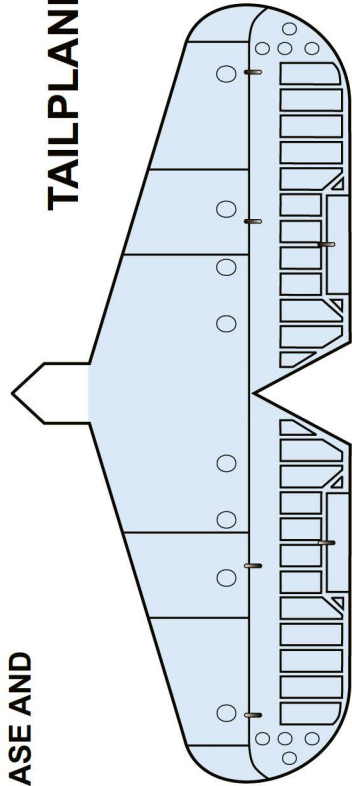

TAILPLANE



WWII AMERICAN HELLCAT

CEREAL-BOX PENNY-WEIGHT PLANE

Copyright • 1993 FLY'N THINGS® (SHEET 2 OF 3)

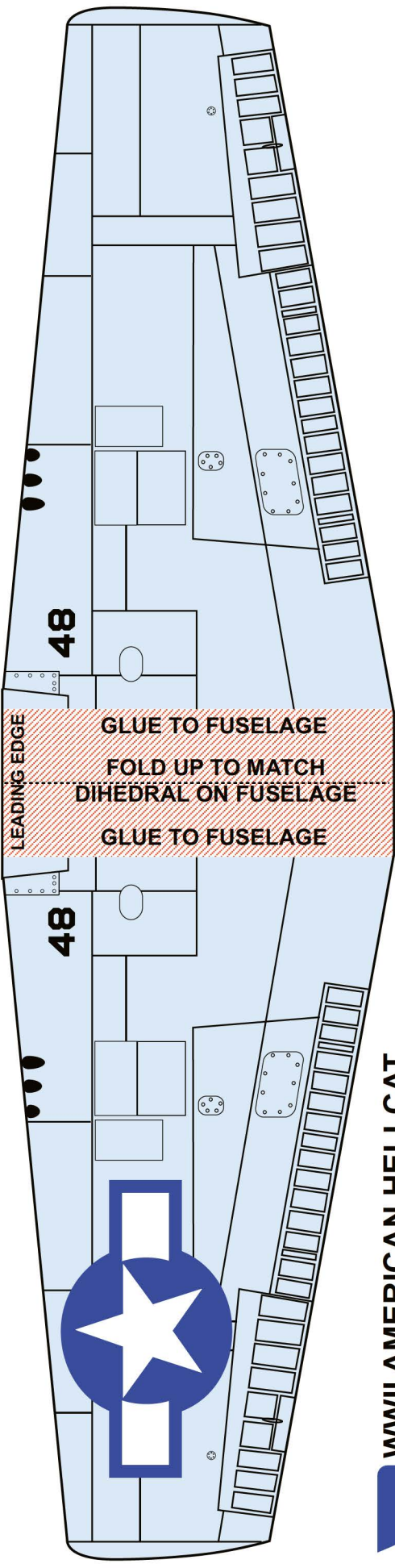
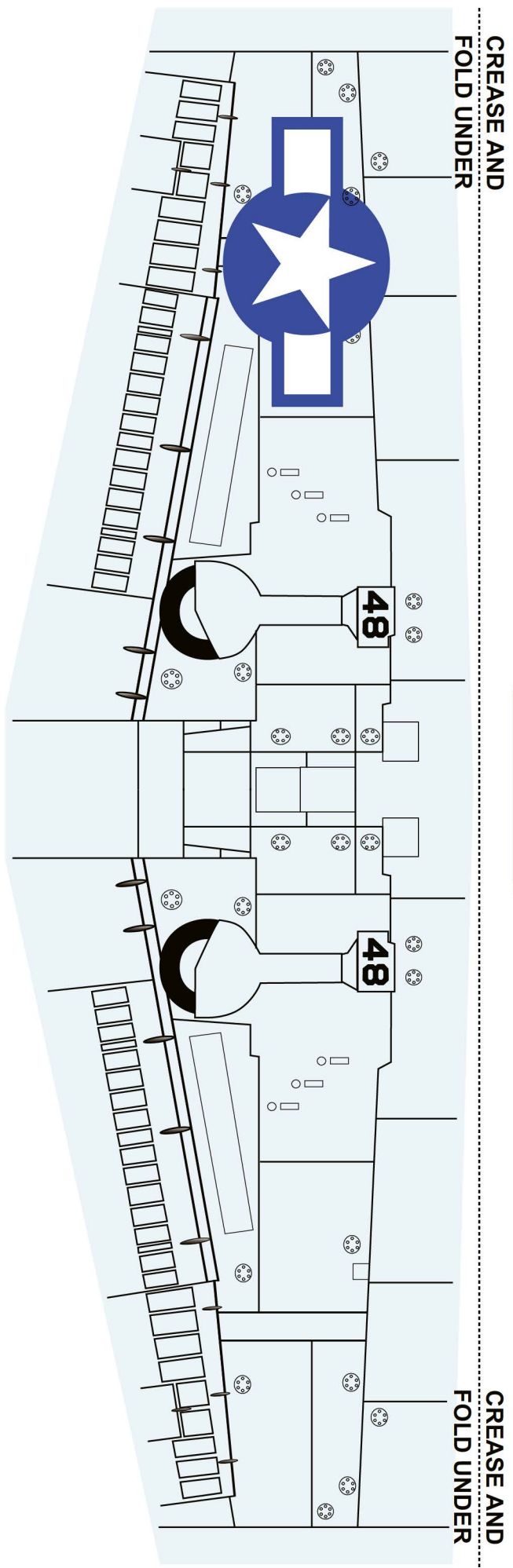

WING

**WWII AMERICAN HELLCAT
CEREAL-BOX PENNY-WEIGHT PLANE**

Copyright • 1993 FLY'N THINGS® (SHEET 3 OF 3)



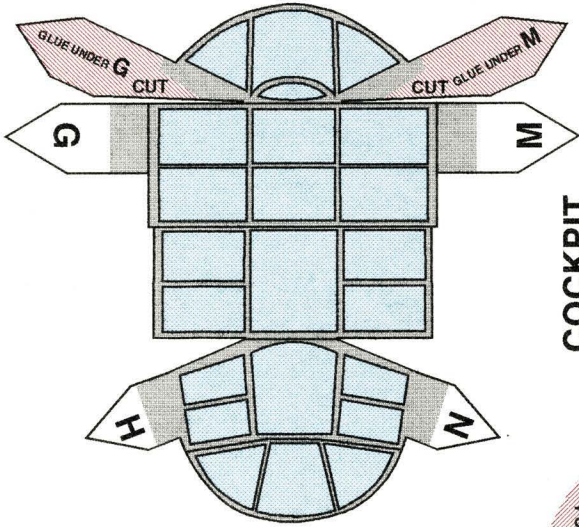

**COCKPIT
COVER**

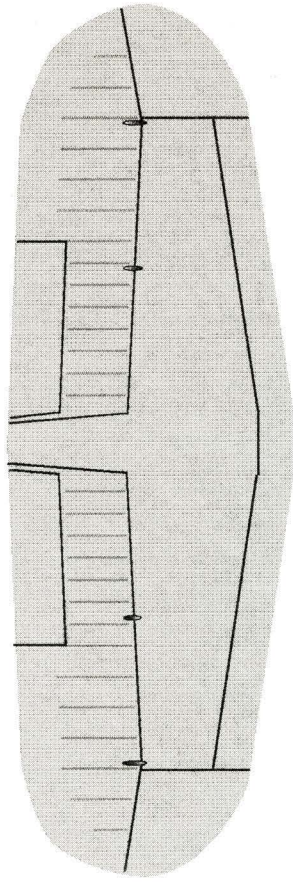

CREASE AND
FOLD UNDER

CREASE AND
FOLD UNDER

TAILPLANE

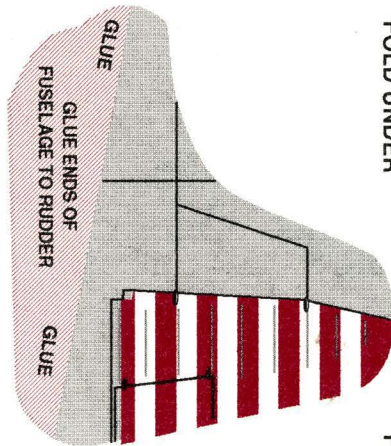
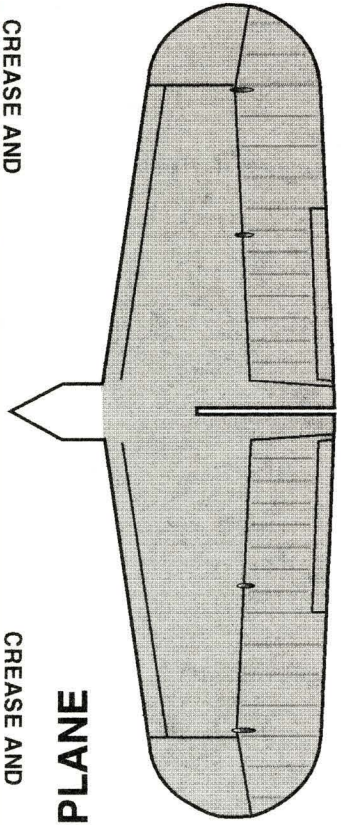

CREASE AND
FOLD UNDER

CREASE AND
FOLD UNDER

RUDDER

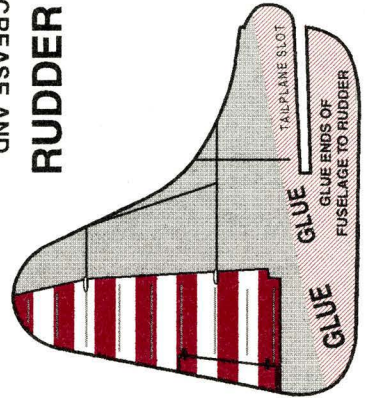

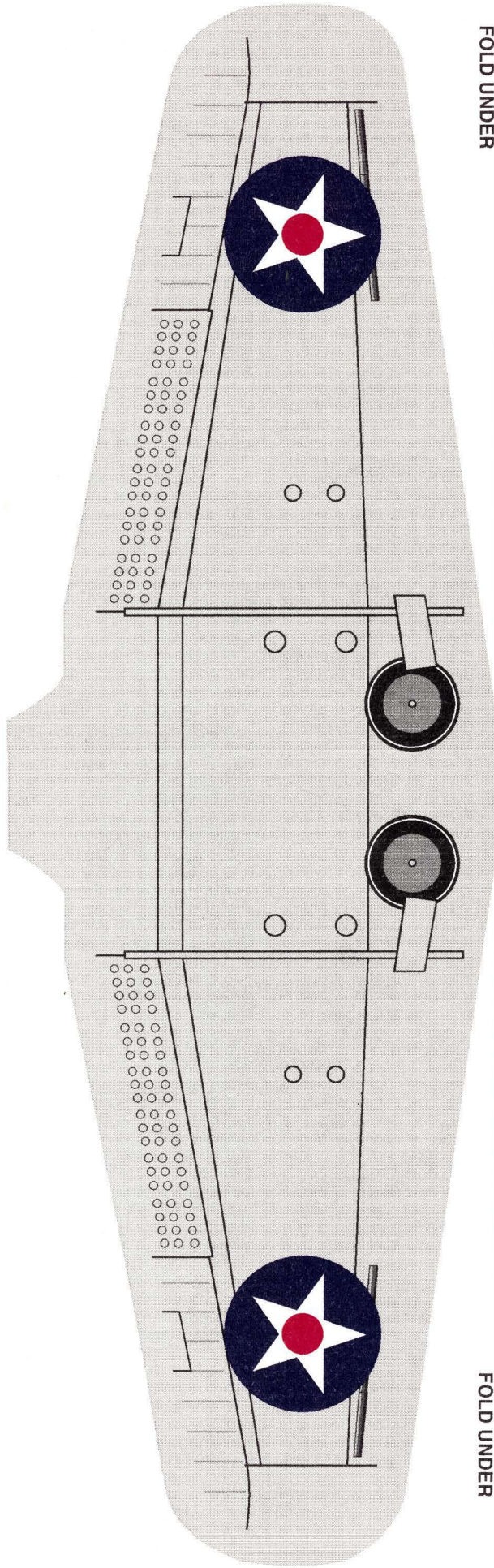

CREASE AND
FOLD UNDER

CREASE AND
FOLD UNDER

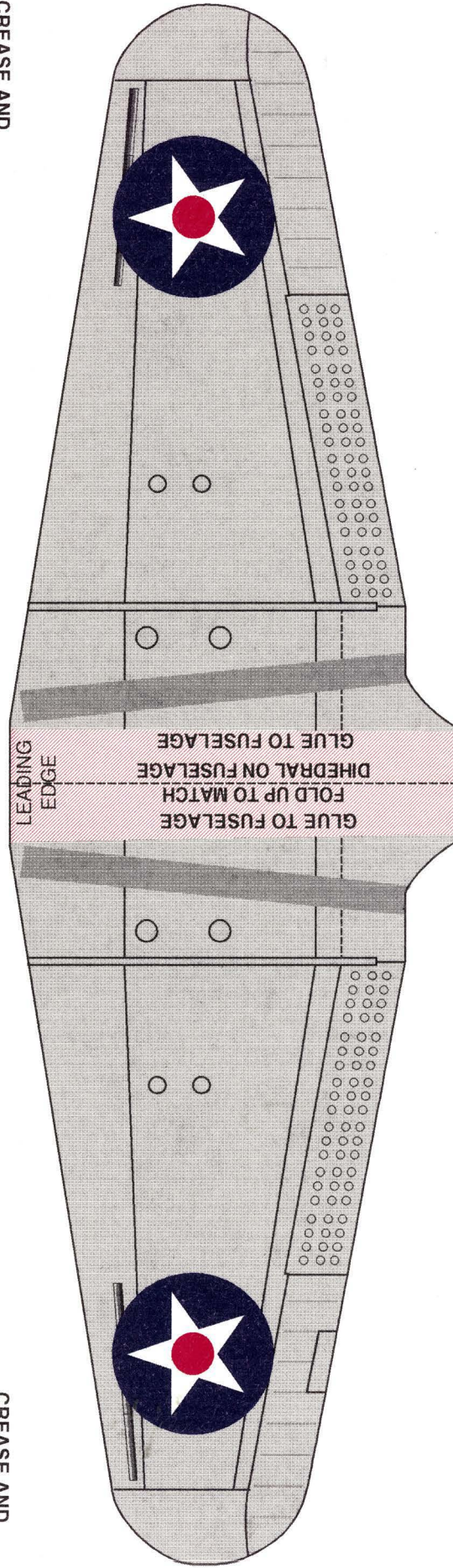

LEADING
EDGE

GLUE TO FUSELAGE
FOLD UP TO MATCH
DIHEDRAL ON FUSELAGE
GLUE TO FUSELAGE

WING



COWL TRIM

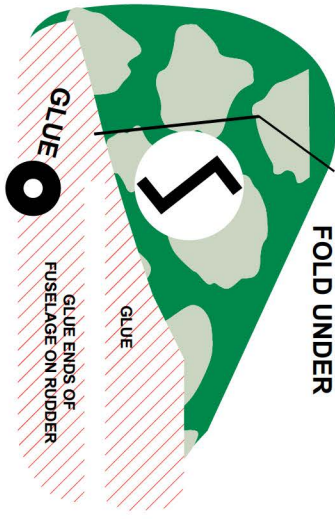

CREASE AND FOLD UNDER

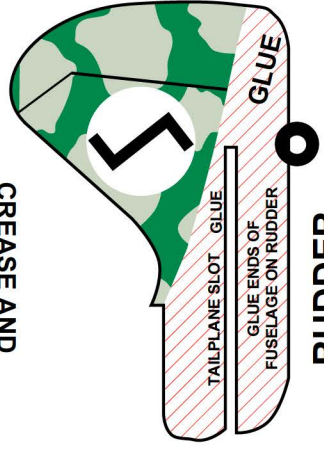

RUDDER

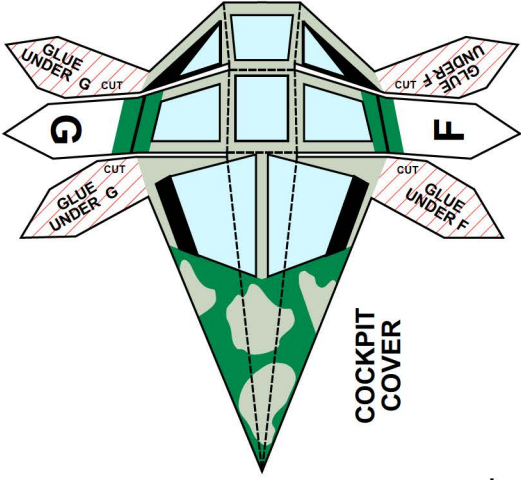

COCKPIT COVER

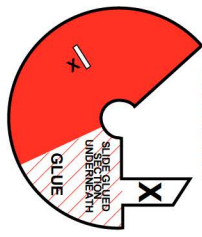

OUTSIDE CONE

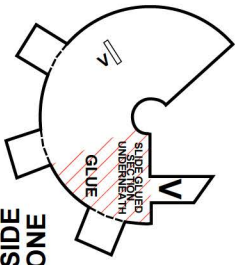

INSIDE CONE

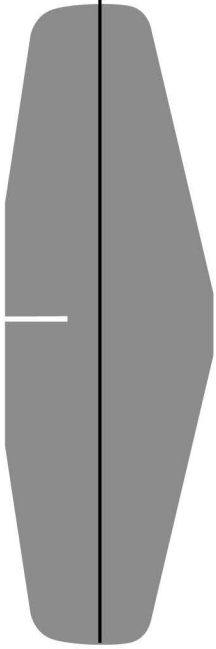

CREASE AND FOLD UNDER

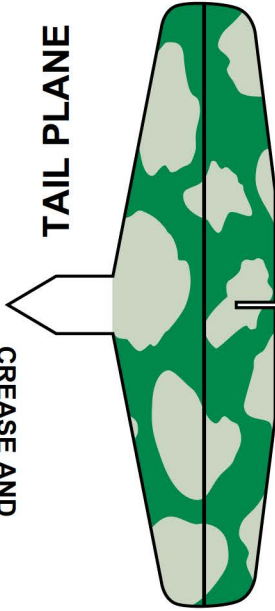

TAIL PLANE

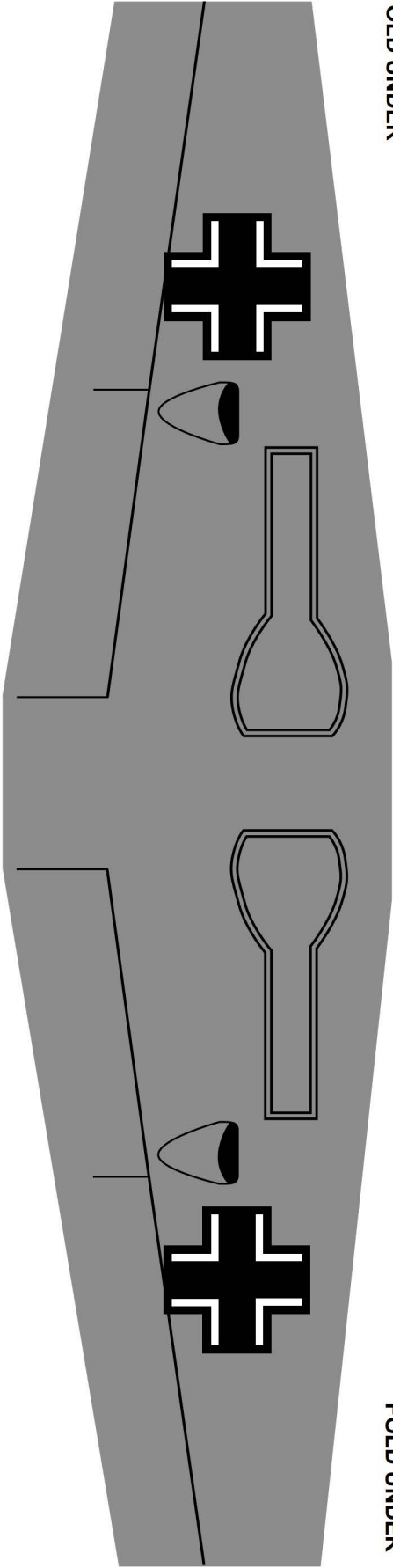

CREASE AND
FOLD UNDER

CREASE AND
FOLD UNDER

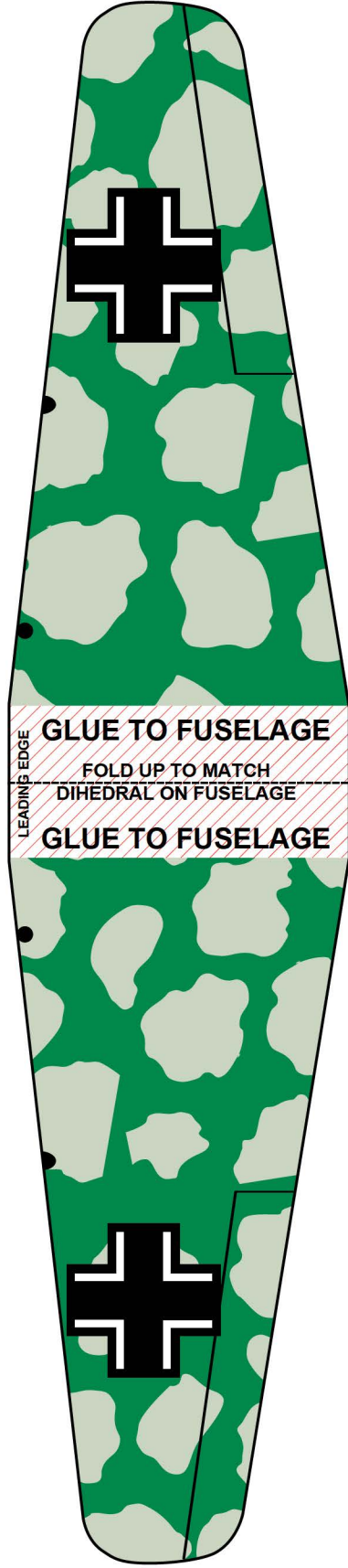

WING