

NEARLY SHIFTABLE SCALING FUNCTIONS

Steven A. Benno and José M. F. Moura

ECE Department, Carnegie Mellon University
5000 Forbes Ave.
Pittsburgh, PA 15213-3890

ABSTRACT

The goal of this paper is to derive an approach for designing nearly shiftable scaling functions for multiresolution analyses (MRAs). Because this method does not increase the sampling density, the sparseness and efficiency of a dyadic grid is preserved. It contrasts with other attempts to the same problem which suffer either from oversampling or from being computationally expensive and data dependent.

The algorithm reshapes a starting scaling function by modifying the Zak transform of its energy spectral density (ESD). The paper shows that although the modified signal does not strictly satisfy the 2-scale equation, the approximation error is sufficiently small. The result is a wavelet representation whose subband energy is "nearly" invariant to translations of its input. The paper will illustrate this property with specific examples.

1. INTRODUCTION

Orthogonal wavelet transforms and multiresolution analyses (MRAs) have become very popular in signal processing. Subband decompositions provide efficient representations. They are computationally fast and the coarse to fine representation is useful in many applications. A major drawback, however, is their lack of translation invariance. To illustrate the problem, suppose one starts with an input signal that lies entirely within a subband. As the input signal is translated in time, energy will escape into other subbands even though the spectral content of the signal does not change. Strang [1] has commented on the invariance problem as a major drawback in using orthogonal wavelet transforms in pattern recognition applications.

Several approaches have been developed to address this problem. One approach maintains full sampling density along the time axis [2] but this representation is highly redundant and computationally expensive. The approach by Mallat [3] develops a translation invariant representation based on the zero-crossings of the full density wavelet representation. While this reduces the redundancy of the representation, it does so at the expense of computational efficiency and requires the full density of samples along the time axis as an intermediate step. The approach of Odegaard, Gopinath, and Burrus [4] has been to find wavelets that minimize the invariance problem. Unfortunately, they do not provide a direct method for making this selection.

This work was partially supported by DARPA through ONR grant N00014-91-J183

Because no discrete representation can ever be truly shift invariant, the approach in [5] is to find *shiftable* representations as an alternative. A function $s(t)$ is said to be shiftable if its arbitrary translates can be represented by its integer shifts,

$$s(t - \tau) = \sum_k a_k s(t - k).$$

This maintains the efficiency of a sparse sampling grid while allowing one to interpolate any intermediate value. The shiftable constructs in [5] depend on the assumption that $s(t)$ is a periodic, bandlimited function. Furthermore, the results of shiftability have not been directly applied to MRAs.

The goal of this work is to construct, in a general way, scaling functions that are shiftable. By doing so, it will be possible to find wavelet representations whose subband energy is invariant to translations of the input. Specifically, we are interested in finding functions that simultaneously satisfy:

1. Shiftability: $g(t - \tau) = \sum_k b_k g(t - k)$.
2. The 2-Scale Equation: $g(t) = \sum_k h_k g(2t - k)$.

Our previous work in [6] addressed the first issue by deriving a general expression for the error in representing the translates of a function by its integer shifts,

$$\mathcal{E}(\tau) = \|s(t - \tau) - \sum_k a_k s(t - k)\|^2.$$

We have shown that this representation error can be expressed in terms of the Zak transform of the energy spectral density (ESD) of $s(t)$,

$$\mathcal{E}(\tau) = 1 - \int_0^1 \frac{|Z_{|s|^2}(f, \tau)|^2}{Z_{|s|^2}(f, 0)} df \quad (1)$$

where $S(f)$ is the Fourier transform of $s(t)$ and assuming $\|s\| = 1$. In general, the Zak transform of a function $h(x)$ is given by (see [7] for a tutorial)

$$Z_h(x, y) = \sum_k h(x + k) e^{-j2\pi y k}.$$

Equation (1) provides a necessary and sufficient condition for the error to go to zero for all τ . We demonstrate that by modifying the Zak transform of the energy spectral density of $s(t)$, a new function $g(t)$ will be constructed so that it is "nearly" shiftable. That is to say that the corresponding

$\mathcal{E}(\tau)$ for $g(t)$ is such that $\mathcal{E}(\tau) < \epsilon$ for some acceptably small ϵ .

But does the nearly shiftable $g(t)$ satisfy the 2-scale equation? This question will be analyzed by finding the Zak domain equivalent of the 2-scale equation which yields a solution to the problem. Hence, we present a method for constructing "nearly" shiftable scaling functions. The concept of working in the Zak domain to modify signals has originated in [8] in the context of multitarget radar problems.

Until now, the only shiftable MRAs were designed for representing bandlimited functions by constructing scaling functions that approximate the sinc function [4, 9]. Our general approach makes no such assumptions and provides an algorithm for constructing new scaling functions as opposed to selecting one from an established library of scaling functions.

Section 2 presents the algorithm and results for constructing shiftable functions. In Section 3, we provide results demonstrating the existence of nearly shiftable scaling functions.

2. THE CONSTRUCTION

The following construction starts with a function that is not shiftable and reshapes it in the Zak domain into a new function that is "nearly" shiftable. The algorithm is iterated as needed to construct a more shiftable function. For the following, the Fourier transform of s is assumed to satisfy

$$A \leq \sum_k |S(f+k)|^2 \leq B$$

where $0 < A \leq B < \infty$ and $\|s\| = 1$.

For a shiftable function, its representation error is zero for all possible τ , $\mathcal{E}(\tau) \equiv 0$, which, from (1), implies

$$\int_0^1 \frac{|Z_{|S|^2}(f, \tau)|^2}{Z_{|S|^2}(f, 0)} df = 1. \quad (2)$$

Equation (2) says that the mean square error $\mathcal{E}(\tau)$ depends only on the area under $|Z_{|S|^2}(f, \tau)|^2$ (normalized by $Z_{|S|^2}(f, 0)$). Hence, the shape of $|Z_{|S|^2}(f, \tau)|^2$ does not affect the $\mathcal{E}(\tau)$, only the area of each slice parallel to the f axis does.

A first candidate solution is to define a new function g through the Zak transform of its energy spectral density as

$$Z_{|G|^2}(f, \tau) = C(\tau)Z_{|S|^2}(f, \tau).$$

where $C(\tau)$ is given by

$$C(\tau) = \left[\int_0^1 \frac{|Z_{|S|^2}(f, \tau)|^2}{Z_{|S|^2}(f, 0)} df \right]^{-1/2}.$$

This construction guarantees that $\mathcal{E}(\tau) \equiv 0$. Unfortunately, it does not guarantee that the resulting $|G(\omega)|^2$ will be non-negative, hence it does not produce a valid energy spectral density. In [6], we have determined the necessary and sufficient conditions for a Zak transform to be the transform of

a valid energy spectral density. However, we will use (2) to define a new intermediate signal $\tilde{G}(f)$ via its Zak transform

$$Z_{\tilde{G}}(f, \tau) = C(\tau)Z_{|S|^2}(f, \tau).$$

The Fourier transform of the nearly shiftable $g(t)$ is now

$$G(f) = |\tilde{G}(f)|^2 e^{j\theta_S(f)}$$

where $\theta_S(f)$ is the phase of original signal $S(f)$. Figure 1 shows the resulting $g(t)$ after one single iteration of applying the algorithm to the Daubechies D8 scaling function normalized to unit energy. Notice that the resulting func-

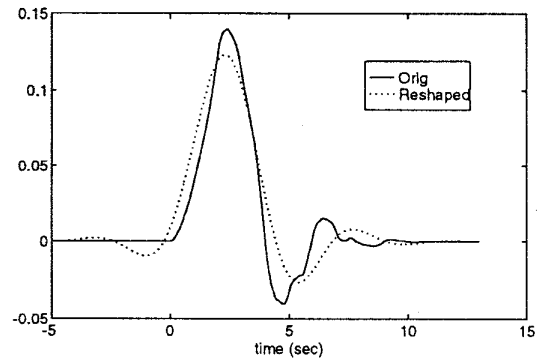

Figure 1: Original D8 and reshaped scaling functions.

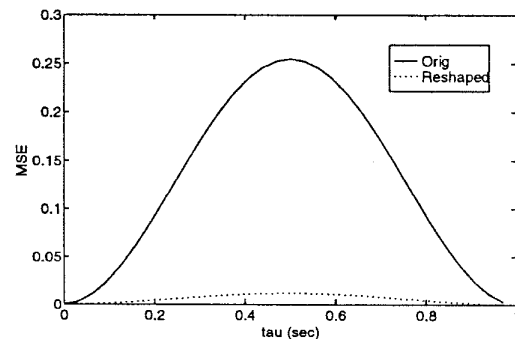

Figure 2: Mean square error $\mathcal{E}(\tau)$ of D8 and reshaped scaling function.

tion does not look drastically different from the original, but, it is much more shiftable as can be seen from figure 2 which plots the mean square error $\mathcal{E}(\tau)$ as a function of τ . The D8 scaling function loses more than 25% of its energy when representing itself delayed half way between grid points whereas the reshaped function loses only 1%. The algorithm can be iterated further for greater loss reduction. This algorithm does not preserve the orthogonality of the

original function. However, one can use the orthogonalizing trick in [10] to generate nearly shiftable orthonormal scaling functions.

3. RELATION TO SCALING FUNCTIONS

In the previous section, we saw how one function can be transformed into another that is more shiftable. In this section, we find that although the resulting $g(t)$ from the previous section does not strictly satisfy the 2-scale equation, it yields an excellent approximation as is demonstrated by its mean square error. Furthermore, the coefficients used in this approximate 2-scale equation themselves converge to a valid scaling function which in turn is an excellent approximation to the $g(t)$ we were interested in the first place. Hence by using these coefficients to specify the scaling function, we provide a means for creating nearly shiftable scaling functions. We start by finding the Zak domain equivalent of the 2-scale equation and using this to identify valid scaling functions.

Define a scaling function $\phi(t/2) = \sum_k h_k \phi(t-k)$ and define $\phi_j(t) = \phi(2^j t)$. Taking the Zak transform of the 2-scale equation yields

$$Z_{\phi_{-1}}(\tau, f) = H(f)Z_{\phi_0}(\tau, f)$$

where $H(f) = \sum_k h_k e^{j2\pi f k}$. This is the Zak domain equivalent of the 2-scale equation. Hence the ratio of the Zak transform of the scaling function with the Zak of itself at the next highest resolution produces a periodic function in f and is independent of τ . The periodicity of $H(f)$ comes free because it is a consequence of the Zak transform's properties. The ratio's independence on τ is because $\phi(t)$ satisfies the 2-scale equation.

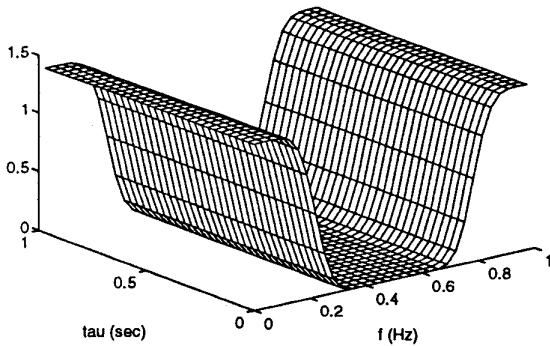

Figure 3: Ratio of Zaks of reshaped function $\frac{Z_{g_{-1}}(\tau, f)}{Z_{g_0}(\tau, f)}$.

To test whether or not the resulting $g(t)$, as derived according to the previous section, satisfies the 2-scale equation, we ran the algorithm first with $\phi(t)$ as the starting function, then with $\phi(t/2)$ to get $g(t)$ and $g(t/2)$ respectively. Next, we took the ratio of their Zak transforms to identify if $g(t)$ satisfies the 2-scale equation. We have used the D8 scaling function once again to demonstrate this

procedure and have plotted the ratio of Zak transforms in figure 3. At first glance, $\frac{Z_{g_{-1}}(\tau, f)}{Z_{g_0}(\tau, f)}$ appears to be independent of τ but closer inspection reveals otherwise. Figure 4

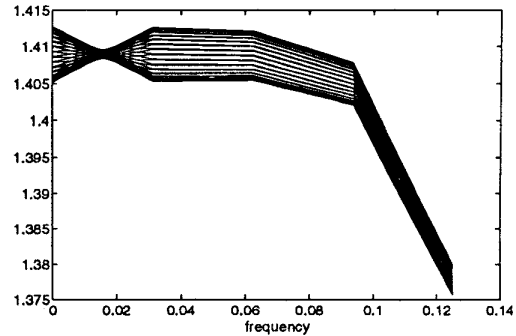

Figure 4: Closeup of ratio of Zak transforms.

is a closeup plot of figure 3 as a function of f . Each line corresponds to a different value of τ . If the ratio were independent of τ , the different lines in figure 4 would not be discernible. Nonetheless, $g(t)$ is an excellent approximation to a scaling function and the coefficients $\{h_k\}$ of the 2-scale equation are given by any slice of the ratio in figure 3 parallel to the f axis. The coefficients for this example are plotted in figure 5. As a measure of the quality of the approximation, consider the mean square error

$$\|g_{-1}(t) - \sum_k h_k g_0(t-k)\|^2 = 3.5 \times 10^{-6}. \quad (3)$$

Figure 5 is a plot of the coefficients generated by this example.

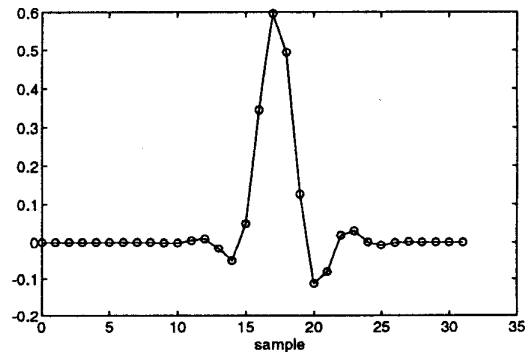

Figure 5: 2-scale coefficients of reshaped D8 signal.

Similar results have been found for all of the Daubechies scaling functions tested. Figure 6 illustrates the resulting reshaped signal when the Daubechies D16 is used as the

initial function and figure 7 shows its corresponding error. As was the case with the D8 scaling function, the resulting function satisfies the 2-scale equation approximately with a mean square error as in (3) of 1.3×10^{-6} .

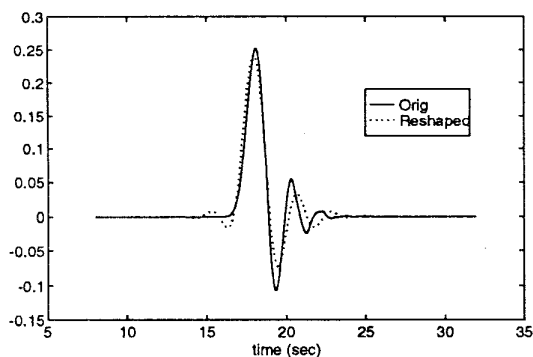

Figure 6: Original D16 and reshaped scaling functions.

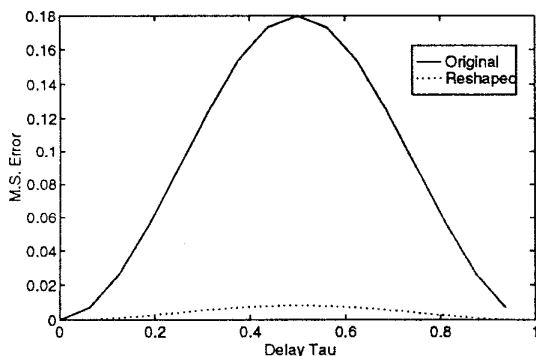

Figure 7: Mean square error $\mathcal{E}(\tau)$ of D16 and reshaped scaling function.

4. CONCLUSION

This paper presents a general construction for generating nearly shiftable scaling functions. The construction reshapes the energy spectral density of the starting signal in the Zak domain and designs the new signal by keeping the phase of the original one. This produces a new function that is much more robust to representing arbitrarily shifted replicas of itself.

Although strictly speaking, this algorithm does not generate a valid scaling function, it has been demonstrated that it does provide a very close approximation. This allows for a wavelet representation whose subband energy is invariant to translations of the input because of the improved shiftable of the new scaling function.

5. REFERENCES

- [1] G. Strang, "Wavelets and dilation equations: A brief introduction," *SIAM Review*, vol. 31, pp. 614-627, Dec. 1989.
- [2] F. Bao and Nurgün Erdöl, "The optimal wavelet transform and translation invariance," in *ICASSP*, Apr. 1994, pp. III-13-16.
- [3] S. G. Mallat, "Zero-crossings of a wavelet transform," *IEEE Transactions in Signal Processing*, vol. 37, pp. 1019-1033, July 1991.
- [4] J. E. Odegard, R. A. Gopinath, and C. S. Burrus, "Optimal wavelets for signal decomposition and the existence of scale limited signals," in *ICASSP*, Oct. 1992, pp. IV-597-600.
- [5] E. P. Simoncelli, W. T. Freeman, E. H. Adelson, and D. J. Heeger, "Shiftable multiscale transforms," *IEEE Trans. Info. Theory*, vol. 38, pp. 587-607, March 1992.
- [6] S. A. Benno and J. M. F. Moura, "Shiftable representations and multipath processing," in *Proc. IEEE-SP Int'l. Symp. on Time-Freq. and Time-Scale Analysis*, Oct. 1994, pp. 397-400.
- [7] A. J. E. M. Janssen, "The Zak transform: A signal transform for sampled time-continuous signals," *Philips Journal of Research*, vol. 43, no. 43, pp. 23-69, 1988.
- [8] L. Auslander and F. Geshwind, "Multi-target ambiguity functions," in J. M. F. Moura and I. M. G. Lourtie, eds., (*Acoustic Signal Processing for Ocean Exploration*), NATO ASI, Kluwer Academic Publishers, July 1992, pp. 473-489.
- [9] T. Frederick and Nurgün Erdöl, "Arbitrary tilings of phase space," in *ICASSP*, Apr. 1994, pp. III-25-28.
- [10] I. Daubechies, *Ten Lectures on Wavelets*. Regional Conference Series in Applied Mathematics. Philadelphia, Pennsylvania: Society for Industrial and Applied Mathematics, 1992.