

**IEEE Copyright Statement:**

Copyright © 2006 IEEE. Reprinted from Proceedings of the IEEE PES General Meeting, Montreal, Canada, June 2006.

This material is posted here with permission of the IEEE. Such permission of the IEEE does not in any way imply IEEE endorsement of any of Carnegie Mellon University's products or services. Internal or personal use of this material is permitted. However, permission to reprint/republish this material for advertising or promotional purposes or for creating new collective works for resale or redistribution must be obtained from the IEEE by writing to [pubs-permissions@ieee.org](mailto:pubs-permissions@ieee.org).

By choosing to view this document, you agree to all provisions of the copyright laws protecting it.

# An Assessment of Reactive Power/Voltage Control Devices In Distribution Networks

Anupam A. Thatte, *Member, IEEE* and Marija D. Ilic, *IEEE Fellow*

**Abstract**—This paper provides an assessment of candidate voltage/reactive power control devices for distribution systems. The recent trend toward Distributed Energy Resources (DERs), and Distributed Generation (DG), in particular, is often based on the rationale to support voltage and compensate for reactive power closer to the end users. This situation calls for a systematic approach to assessing alternatives for voltage control, both old and new. In this paper we illustrate on a simplified distribution network various voltage control devices, such as DERs, DGs, Under-Load-Tap-Changing Transformers (ULTCs), Static Var Compensators (SVCs), and SuperVar controllers. We illustrate how their dynamic characteristics differ. Moreover, we show that enhancing control logic of the existing controllers is often as good as adding the latest hardware. In order for such enhanced performance to be achieved a more involved system-wide coordination is often necessary. The ultimate decision is based on several criteria and it reflects trade-offs between the complexity of devices, their cost and communications requirements.

**Index Terms**—Distributed Energy Resources, Distributed Generation, Voltage Control, Under-load Tap-Changing Transformers, Shunt Capacitors, Electric Power Distribution Systems, Nonlinear Control.

## I. INTRODUCTION

As the electric power systems continue to exhibit vulnerability without adequate voltage/reactive power support, there has been a renewed effort toward improving their voltage control [6],[7],[1]. The recent report by Evans [1] demonstrates that Distributed Energy Resources (DERs) placed at the right locations and with the right characteristics and operating profiles can improve the performance of an integrated network, including both distribution and transmission. The idea has been pursued that DERs could support transmission voltages indirectly, in addition to maintaining the distribution level voltages. These ideally located, sized, and operated projects are referred to in [1] as the “Optimal DER Portfolio” for a given system. The report

Manuscript received December 5, 2005. This work was partly supported by the TVA grant to Carnegie Mellon University.

Anupam A. Thatte is a graduate student in the ECE Department at Carnegie Mellon University.

Marija D. Ilic is a Professor of ECE and EPP at Carnegie Mellon University, PH B25, 5000 Forbes Avenue, Pittsburgh, PA.15213-3890 USA (412-268-9520; fax: 412-268-3890; e-mail: milic@ece.cmu.edu).

claims that the grid benefits associated with such projects are readily assessed and quantified.

In this paper we take a broader view than the one taken in [1]. In addition to considering strictly static voltage constraints and their optimal levels, it is essential to understand the effects of voltage control on system dynamics. The system must remain stable in the face of load variations and robust with respect to the unknown parameters. Such an assessment is attempted in this paper. We study the effects of different reactive power sources such as DGs, controllable capacitor banks, SVCs and SuperVars on the dynamic response of a simple distribution network. While only a radial network is considered for simplicity, the results can be extended to studies of meshed networks as well.

## II. CAPACITOR BANKS

### A. Fixed Capacitor Banks

We start by choosing a site for fixed capacitor banks in support of static load. Fixed capacitor banks are one of the most often used devices in power systems for reactive power compensation / voltage support.

We consider an integrated transmission and distribution network, consisting of eight (8) buses as shown in Fig. 1. The line between buses 1 and 2 is a transmission line to which a radial distribution network is connected. The base voltage is 100 kV and bus 1 is considered as the slack bus. Under normal conditions the objective is to maintain voltages at the buses between 0.97 and 1.03 pu. Here we are interested only in the feasibility of the solution, and not in optimization. To assess the power flow feasibility, we increase the load at each tier, until power flow no longer converges. The voltages at all distribution buses are outside the specified limits. In particular the voltages at buses 2 to 8 are at unacceptable values. To maintain the desired voltage profile we start by adding a fixed capacitor bank to the bus at the end of the transmission line.

We start by adding a large capacitor bank having a rating of 210 MVAR at a voltage of 1 pu. The voltage at bus 2 still exceeds the desired limit. But the voltages at the other buses are far below the lower limit. To increase these voltages to within the desired limits, the size of the capacitor bank at bus 2 will have to be increased. But this will cause significant over-voltage at bus 2.

Next consider installing capacitor banks at the buses in the lower tier, i.e. instead of a single capacitor bank at bus 2, we install capacitor banks at buses 3 and 4. Consider two banks rated at 70 MVAR at a voltage of 1pu, each, at buses 3 and 4. Load flow results for this network indicate a similar outcome. The voltage at buses 3 and 4 is higher than the acceptable limit so we can not add more capacitors at these buses. But at the same time the voltages at the buses on the next tier are below the acceptable limit and this requires additional capacitors to be added. So this is not a viable solution either.

Finally, consider adding capacitor banks only to the last tier of buses. 24 Mvar banks are added to buses 5, 6, 7 and 8. From the results of the load flow, it is noted that the voltages at all buses are within desired limits. Further we see that the total of the rated capacities of the capacitor banks in this case is much lower than that in the previous two cases. This leads to the conclusion that it is better to add reactive power compensation closer to the loads rather than at the substation.

We arrive at this result since when we add reactive power compensation closer to the receiving end of the line, rather than the sending end, the reactive power flow in the network is reduced more and hence the reactive power losses are greatly reduced. This means that the reactive power support is technically more effective if connected near the loads rather than at the substation. The economics of having multiple capacitor banks of small sizes spread across the distribution system versus having few large capacitor banks at substations is outside the scope of this paper. However, even if the basic cost analysis led to the conclusion that it is more cost-effective to have a few large capacitors, this solution may not be technically acceptable, as illustrated above.

### B. Mechanically Switched Capacitor Banks

Since load varies during the day instead of fixed capacitor banks switched capacitor banks are used. As the load varies the capacitors are switched on or off to adjust the voltage to within the desired limits. The standard logic is to increase the number of capacitor banks as the voltage decreases, but this is not always the most effective [8].

To illustrate effects of the standard control of mechanically switched capacitors, consider switched capacitor banks which can be switched in steps of 6 MVar each, up to a maximum of 24 MVar at voltage 1 pu. at all buses in the last tier. The load flow results show that the load at bus 5 reduces to the minimum load, thus the voltages will increase due to over-compensation by the capacitors. In such a case the capacitors can be switched off so as to reduce the voltages at the buses, to bring them within the desired limits.

Consider the case when the load at bus 5 drops to P=16 MW, Q=8Mvar. Then by switching off two of the capacitors of the bank at bus 5 we obtain load flow results which indicate that the voltages at the buses are closer to the desired range.

To achieve finer control of the voltages one could use

smaller steps in the capacitor banks.

## III. UNDER LOAD TAP CHANGING TRANSFORMERS (ULTC)

### A. Conventional Control Logic

Load voltages in a radial distribution network may also be controlled by using under load tap changing (ULTC) transformers. Consider an ULTC transformer ( $X=0.01$ ) connected at the end of the distribution line between buses 3 and 5, instead of the capacitor bank as a candidate voltage controller to regulate voltage at bus 5, with the aim of keeping it between 0.95 and 1.05 pu. With a tap ratio of 1.08 we obtain the voltages at buses 3 and 5 as 0.9375 and 0.9511 pu respectively. This indicates the basic problem with the ULTC transformer. The voltage at its primary end drops significantly below the limit. This is because the ULTC is not actually supplying any reactive power when the transformer ratio adjusts, but merely re-distributing the power from the bus at the primary end of the transformer to the bus at the secondary end. This means that reactive support now has to be provided at the primary end by any suitable device, e.g. distributed generator, capacitor etc.

### B. Potential Operating Problems Caused by Malfunctioning of Capacitor Banks and ULTCs

Several early voltage collapses have been related to the malfunctioning of the ULTCs, in particular. Similarly, unexpected instabilities have been observed when large capacitor banks were placed to increase power transfer across far electrical distances. Because of this, it is necessary to assess next whether there is any voltage collapse seen at bus 5 when the load suddenly drops. The ULTC transformer is placed between buses 3 and 5. Consider a load variation at bus 5. The load suddenly increases from P=28 MW, Q=14 Mvar to P=32 MW, Q=16Mvar at time t=10 seconds. As a result of this increase in load the voltages at the buses drop. The voltage at bus 5 drops below 0.95 as shown in Fig. 2. The ULTC controller is supposed to detect this and automatically adjust its tap position to bring the voltage back to within the desired range. However we see that the ULTC malfunctions when it reacts such that a tap position increases to increase the voltage as reactive power consumed increases, and vice versa. This standard relay type control of the ULTC is a direct cause of this instability.

This conventional relay type control is of the form [8].

$$a_{ij}(k+1) = a_{ij}(k) + d_j f(V_j(k) - V_j^{ref})$$

where  $a_{ij}$  is the tap position of the ULTC located between buses  $i$  and  $j$ ;  $V_j$  is the voltage at the secondary end of the transformer;  $d_j$  is the step size in the change of the tap position during one operating cycle and  $f(V_j - V_j^{ref})$  is the relay type control function governing the operation of the ULTC, which is given by

$$f(V_j - V_j^{\text{ref}}) = \begin{cases} 1, & V_j - V_j^{\text{ref}} > \Delta V_j \\ 0, & |V_j - V_j^{\text{ref}}| \leq \Delta V_j \\ -1, & V_j - V_j^{\text{ref}} < -\Delta V_j \end{cases}$$

At each tap position the transformer should also satisfy the load flow equations.

A sequence of slowly changing directly controlled load voltages via ULTC transformers can be viewed as slow voltage dynamics. Approximate equations for such dynamics are derived by combining the ULTC control function given above and the load flow equations linearized around the initial steady state voltages [8]. It is proposed in [8] and [2] that if the control strategy takes into account network and loading conditions instead of just the regulation of voltage values, many problems could be avoided. From [8] and [2] we know that the stability depends on the nature of the system Jacobian. It was shown in this work that under certain conditions the relay type control adds too large capacitance, and hence system Jacobian does not remain positive definite, thus leading to the unstable dynamics.

### C. New Control Logic for ULTCs

To correct the problem related to the standard control logic of ULTCs, [2] proposes a new control law. The new control law has to use the information on the Jacobian matrix to overcome present control problems. Variable structure system control was suggested as one of the ways to deal with this problem. The new control law uses the information about the response nature of the system to control changes by adapting to the sign change of the Jacobian. The control law suggested in [2] is used to simulate a stable voltage dynamic, as shown in Fig. 3.

## IV. MODELS RELEVANT FOR CAPTURING INTERDEPENDENCE BETWEEN CAPACITIVE SUPPORT AND AUTOMATIC VOLTAGE REGULATORS.

In an actual power system operation, voltage related operating problems may be very complex. They could evolve at several rates and are generally a result of more than one cause. In particular, an ultimate voltage collapse-related blackout can be caused by a combination of: 1) power plants exceeding reactive power generation limits and the Automatic Voltage Regulators (AVRs) losing the ability to regulate terminal voltage on the power plant; 2) the delivery losses being excessive so that steady state stability limits are reached and the power required by the load cannot be delivered; 3) by the unacceptably large capacitors making the network primarily capacitive, in which case an increase in power cannot be counteracted by an increase in capacitive support (for the fixed power load); in this case leading power factor is not right, one needs a lagging power factor [7]; 4) by the ULTCs malfunctioning, i.e. forcing the load to maintain fixed voltage and, therefore, absorb constant reactive power even in the case

when there is not enough reactive power delivered, and/or 5) a complex combination of any of these.

### A. Small Signal Instability

[3] introduces the three conditions which should be satisfied for the state variables relevant for voltage dynamics to be small signal stable around an equilibrium point.

These conditions are:

1.  $\partial V_t / \partial E_q' > 0$
2.  $\partial E_{fd} / \partial R_f > 0$
3.  $\partial i_d / \partial E_q' = -\epsilon$      $\epsilon = \text{small positive number}$

Where  $E_{fd}$  is the field excitation voltage of the generator,

$V_t$  is the terminal voltage,  $i_d$  is the direct-axis current,  $R_f$  is the feedback compensator state and  $E_q'$  is the voltage behind the transient reactance.

Condition 1 requires that a positive increment in  $E_q'$ , results in a positive increase in the terminal voltage.

Condition 2 requires that the excitation control have proper control over the field voltage.

Condition 3 accounts for why  $E_q'$  is responsible for the unstable mode under some operating conditions.

In what follows we illustrate such cases. When we add capacitors to the network we can increase the power transfer capability of the power lines. But adding too large capacitors can cause the network to be less stable. A capacitive network may result in an operating condition which violates condition 3, as stated in [3].

The details of the capacitor banks connected to the last tier of buses are as follows. Capacitors at buses 5 and 6 have rating of 40 Mvar at a voltage of 1 pu; and those at buses 7 and 8 have rating of 30 Mvar at 1 pu.

Consider a small variation in the reactive part of the load at bus 5. The load changes from  $P=50$  MW,  $Q=25$  Mvar to  $P=50$  MW,  $Q=24.80$  Mvar. The voltage change at bus 5, due to this small decrease in load, is shown in Fig. 4. We would have expected to see an increase in the voltage at the bus since there is a decrease in the reactive load. Instead we see that there is large decrease in voltage at bus5. This is clearly a case of small signal instability. [3] suggests that this is caused by the violation of condition 3. (Resistive part of network as seen by generator is negligible. Or the network is capacitive).

Moreover [3] suggests that a high exciter control gain may result in small signal instability (condition 2). In order to investigate what happens when the exciter gain  $K$  is reduced, we compare the system response for different values of the exciter gain. The system response for  $K=150$  is shown in Fig. 4, and for  $K=1$  it is shown in Fig.5.

We see from Fig. 5 that the voltage is stable, and does not collapse. This illustrates the assertion in [3]. To correct the above problem, [2] proposes a new control law. The new control law has to use the information about the system

Jacobian matrix to overcome the control problems.

### B. Large Signal Instability

[3] states that a large signal voltage instability with terminal voltage changing in an unbounded manner takes place only if  $E_q'$ , the voltage behind the transient reactance, becomes large signal unstable. For a load modeled as a constant impedance load this may occur if the load is predominantly capacitive or if the generator is under-excited.

Another possible case in which  $E_q'$  may become unstable, even with the network inductive in nature, is when the load is modeled as a constant power load.

If the reactive power output limit of the generator is high then the system will stay stable although some voltages may be out of bounds of the desired voltage profile. But if we limit the availability of generator reactive power then we can see large signal voltage instability.

To illustrate this consider a load variation at bus 5. The load changes from P=20 MW, Q= 10 Mvar to P=30 MW, Q= 20 Mvar.

The resulting voltage dynamics are shown in Fig. 6. From Fig. 6, we see a stable transition to a new equilibrium point, since the value of maximum field emf ( $E_{fd}^{\max}$ ) of the generator is high.

However if the limit on the reactive power of the generator is lower then the system may experience a voltage collapse. Consider the following case where the  $E_{fd}^{\max}$  of the generator is limited thus resulting in a limit on the reactive power output. The result of this simulation is shown in Fig. 7. As seen in Fig. 7, because of the limit on the field emf (i.e. on the reactive power) we see that the voltage becomes unstable.

### C. Control of Dynamic Voltage Problems

Dynamic voltage problems, often referred as the voltage collapse, have been associated with bifurcation points.

Designing control for avoiding such problems has been the subject of some recent research.

Various controllers proposed generally employ feedback which is a dynamic function of the speed  $\omega$ . Such control was first used in designing the Power System Stabilizer (PSS)

It is suggested in [9, 10] that such controllers do not affect the position of the saddle node bifurcation. Instead:

- One control law transforms a subcritical Hopf bifurcation into a super critical Hopf bifurcation. This is a non linear control which employs a cubic feedback with measurement of  $\omega$ .
- Another design involves changing the critical parameter value at which the Hopf bifurcation

occurs by a linear feedback control.

However, a high gain linear feedback may destabilize modes that are open-loop stable. This is shown in Fig. 4. Due to the variation in load and the high gain the voltage becomes unstable and settles to a new equilibrium at an unacceptably low value.

Also in some situations a linear feedback which locally stabilizes an equilibrium may result in globally unbounded behavior. For a small feedback gain the bifurcation will reappear at a different parameter value. This is demonstrated in the simulation shown in Fig. 5. We reduced the gain, and prevented the voltage from dropping to lower equilibrium. The instability is now postponed and for the given load variation the system remains stable.

## V. COMPARISON OF DIFFERENT REACTIVE POWER CONTROL DEVICES

### A. Performance in Radial Networks

Finally we compare the performance of the following devices which are used for reactive power compensation.

1. Fixed Capacitors
2. Static Var Compensation (SVC)
3. SVC with high gain and PID control.
4. SuperVARs [4]

#### 1. Fixed Capacitors

With fixed capacitors of 24 Mvar connected to all the buses in the last tier, we get the load flow resulting in voltages within acceptable limits at all buses. Next consider a small variation in the reactive part of the load at bus 5, at time t=100 seconds. The load changes from P=30 MW, Q=15 Mvar to P=10 MW, Q=5 Mvar. The resulting voltage dynamics are shown in Fig. 8. It can be seen that the voltage at bus 5 is within limits but the voltages at buses 1 and 3 are very high.

#### 2. Static Var Compensation

Next we add a SVC at bus5. Again we change the load from P=30 MW, Q=15 Mvar to P=10 MW, Q=5 Mvar. The resulting voltage dynamic shown in Fig. 9 indicates a voltage spike due to the large drop in load. The SVC then adjusts to reduce this voltage.

#### 3. Static Var Compensation with high gain and PID control

The first SVC model only has a low integral gain term.

The second “improved” SVC model also includes proportional and derivative gain. Also the integral gain is much higher. This gives a better performance than the first model.

Next we use the “improved” SVC instead. The results are shown in Fig. 10.

Now we see that the voltage spike lasts for a much shorter time (only about a tenth of the duration with the old SVC) and hence will be ignored by the protection devices. This may be “acceptable”.

#### 4. SuperVar

SuperVar [4] is a Dynamic High Temperature Superconducting synchronous condenser.

As seen in Fig. 11 the voltage spike is reduced but there are some oscillations that last for a few seconds.

To simulate the SuperVar, we have used the model for a synchronous condenser, but modified it to match the characteristics mentioned in [4]. The resistance and reactance was set at a lower value than the synchronous condenser model. Also the upper limit for the field emf and current was set higher. These settings result in lower losses, and a better transient response.

For further comparison of SuperVARs see [4].

#### 5. Distributed Generator (DG)

The performance of the DG for reactive power compensation is not as fast as that of the SVC or the SuperVar.

However a DG also provides real power. This could be useful in case the transmission lines/distribution lines are working too close to their maximum limit.

#### B. Performance in Meshed Networks

Now we repeat the above simulations for the meshed network. We connect buses 6 and 7 with a distribution line ( $X=0.4$  pu)

The results obtained are quite similar to those for the radial network. Comparing the power flow results we see that due to the new inter connection the benefits of the reactive power sources are spread to buses 7 and 8, resulting in higher voltages at those buses with the interconnect than without. This means that for meshed networks the reactive power control benefits adjacent buses also and not just the bus to which the control is connected. Therefore, it makes sense for customers close together to team up and invest in a device for reactive power compensation.

## VI. CONCLUSION

This paper provides an assessment of candidate voltage/reactive power control devices for distribution systems. The recent trend toward Distributed Energy Resources (DERs), and Distributed Generation (DG), in particular, is often based on the rationale to support voltage and compensate for reactive power closer to the end users. This situation calls for a systematic approach to assessing alternatives for voltage control, both old and new. In this

paper we illustrate on a simplified distribution network various voltage control devices, such as DERs, DGs, Under-Load-Tap-Changing Transformers (ULTCs), Static Var Compensators (SVCs), and SuperVar controllers. We illustrate how their dynamic characteristics differ. Moreover, we show that enhancing control logic of the existing controllers is often as good as adding the latest hardware. In order for such enhanced performance to be achieved a more involved system-wide coordination is often necessary. The ultimate decision is based on several criteria and it reflects trade-offs between the complexity of devices, their cost and communications requirements.

Unfortunately, there is very little documented field data to provide evidence of what may have happened in the actual operation during voltage control-related problems. Moreover, it is difficult to relate field evidence to a mathematical sub-problem of interest, with little of speculation remaining controversial.

One fact is, however, for certain. As different combinations of mechanically switched and fast power electronically switched voltage controllers are being deployed, the possibilities for unexpected problems of one or the other type are likely to increase. The favorite example of the first author is General Electric’s struggle some time ago to coordinate several of these controllers in an electrically close area. In this paper we recognize the overall complexity of the problem, and proceed in steps by assessing sub-problems under well-defined assumptions.

## REFERENCES

- [1] P. Evans, “Optimal Portfolio Methodology for Assessing Distributed Energy Resources Benefits for the Energynet,” California Energy Commission, PIER Energy-Related Environmental Research, 2005
- [2] M. Ilic, K. K. Lim, “Control Coordination on the distribution power network”, Proceedings of the IEEE International Symposium on Circuits and Systems, Singapore, June 1992, pp. 1232-1235.
- [3] M. Ilic, Mak Fong, “Classification of voltage problems in electric power systems,” International Journal on Electrical Power and Energy Systems, 15, 377-385, April 1993.
- [4] Swarn Kalsi, David Madura, Ray Howard, Greg Snitchler, Tim MacDonald, Dale Bradshaw, Ian Grant and Mike Ingram, “Superconducting Dynamic Synchronous Condenser For Improved Grid Voltage Support”, Presented at 2003 IEEE T&D Conference and Exposition, Dallas, Texas, Sept. 2003, Volume: 2, pp 742- 747
- [5] H.O. Wang and E.H. Abed, "Control of nonlinear phenomena at the inception of voltage collapse," Proceedings of the 1993 American Control Conference, pp. 2071-2075, San Francisco, CA, June 2-4, 1993.
- [6] Carson Taylor, “Line drop compensation, high side voltage control, secondary voltage control—why not control a generator like a static var compensator”, Panel Session on Power Plant Secondary (high side) Voltage Control, IEEE/PES 2000 Summer Meeting, 16-20 July 2000, Seattle, Washington.
- [7] C. W. Taylor and R. Ramanathan, “BPA Reactive Power Monitoring and Control following the August 10, 1996 Power Failure,” Invited paper, VI Symposium of Specialists in Electric Operational and Expansion Planning, Salvador, Brazil, May 24-29, 1998
- [8] Medanic, J. Ilic, M., Christensen, J., Discrete Models of Slow Voltage Dynamics for Under Load Tap Changing Transformer Coordination," IEEE Transactions on Power Apparatus and Systems PWRS-2 873-882, November 1987.

- [9] H.O. Wang, E.H. Abed and A.M.A. Hamdan, "Bifurcations, Chaos and Crisis in Voltage of a Model Power System," IEEE Transactions on Circuits and Systems I, Vol 41, No.3, Mar 1994.
- [10] H.O. Wang, E.H. Abed, R.A. Adomaitis and A.M.A. Hamdan, "Control of Nonlinear Phenomenon at the Inception of Voltage Collapse", Technical Research Report, Institute for Systems Research.

**Marija D. Ilic** is a professor in the Electrical and Computer Engineering and Engineering Public Policy Departments, Carnegie-Mellon University. Her interest is in control and design of large-scale systems. She is an IEEE Fellow and an IEEE Distinguished Lecturer. She has co-authored several books on the subject of large-scale electric power systems: Ilic and Zaborszky, Dynamics and Control of Large Electric Power Systems, John Wiley & Sons, Inc., 2000; Ilic, Galiana, and Fink (eds.), Power Systems Restructuring: Engineering and Economics, Kluwer Academic Publishers, 2<sup>nd</sup> printing 2000; Allen and Ilic, Price-Based Commitment decisions in the Electricity Markets, Springer-Verlag London Limited, 1999; Ilic and Liu, Hierarchical Power Systems Control: Its Value in a Changing Industry, Springer-Verlag London Limited, 1996; Skantze and Ilic, Valuation, Hedging and Speculation in Competitive Electricity Markets: A Fundamental Approach, Kluwer Academic Publishers, 2001.

**Anupam A. Thatte** received his B.E. degree in Electrical Engineering from Pune University, India in 2004. He is currently working towards an M.S. degree in the ECE Department at Carnegie Mellon University. His current research interests are in power systems and control.

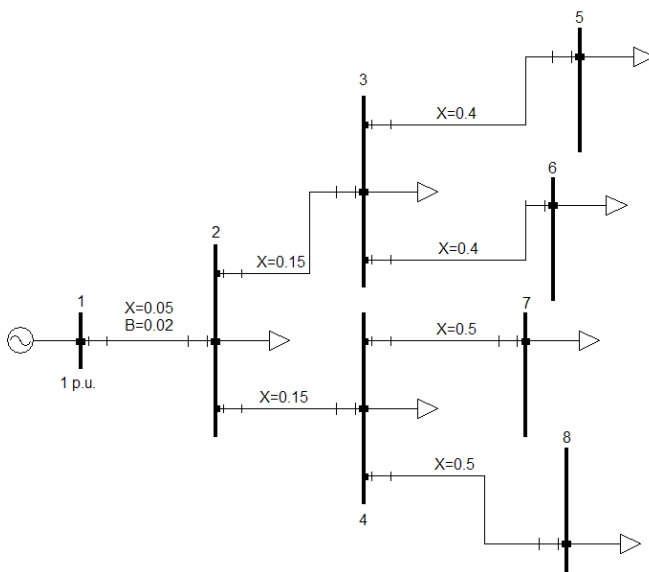

Fig. 1. A simple distribution network.

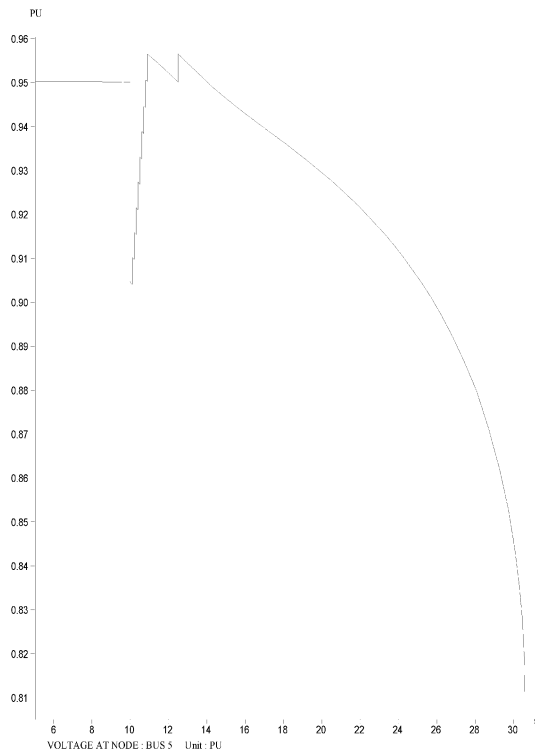

Fig. 2. Voltage drop in response change of load from P=28 MW, Q=14 Mvar to P=32 MW, Q=16Mvar; with standard relay type control of the ULTC transformer.

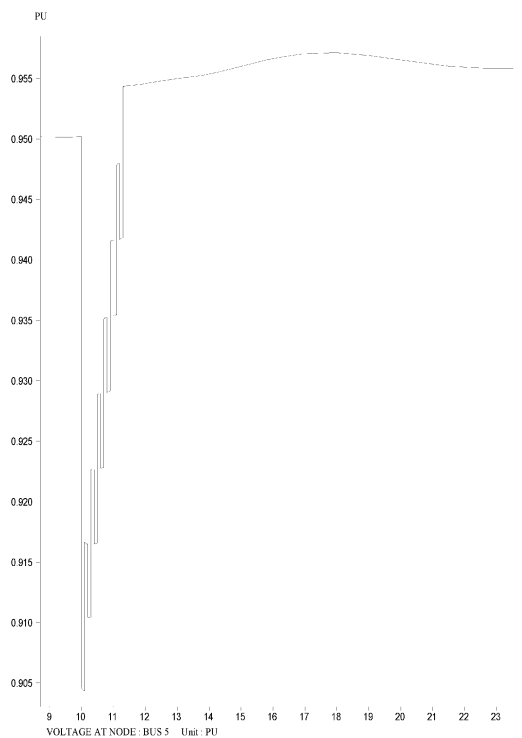

Fig. 3. Stable voltage using an ULTC with sliding mode control [2].

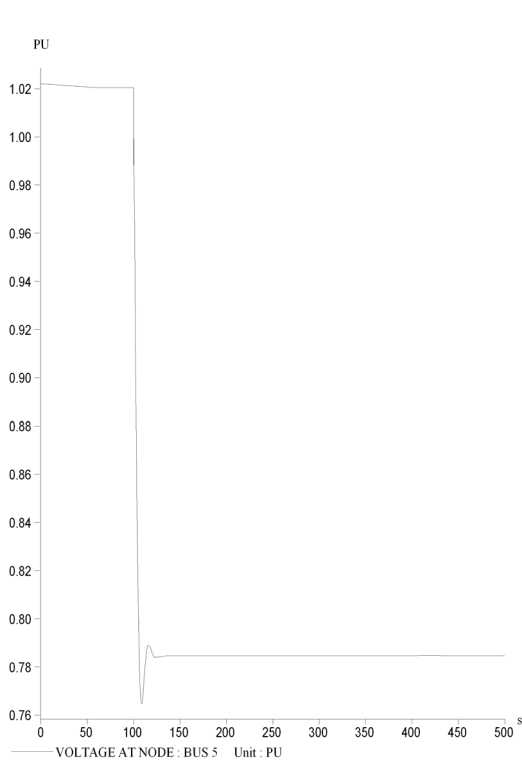

Fig. 4. Voltage change at bus 5 for small load change and high exciter gain

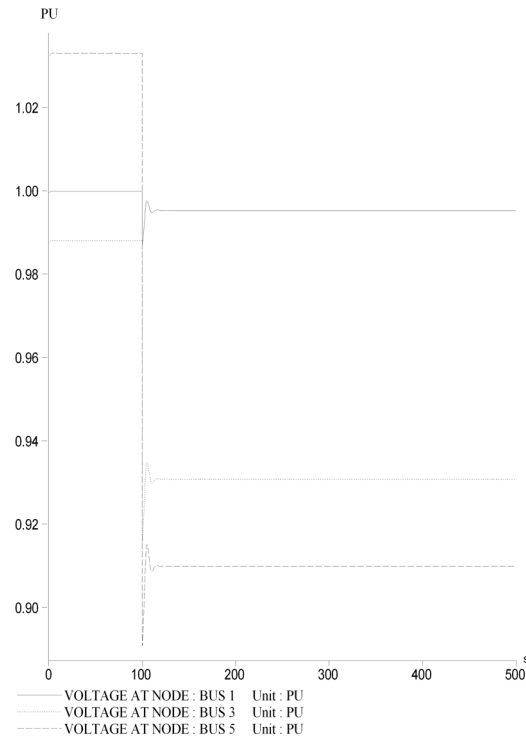

Fig. 6. Stable voltage change at buses for large load change, when the limit on the reactive power of the generator is high.

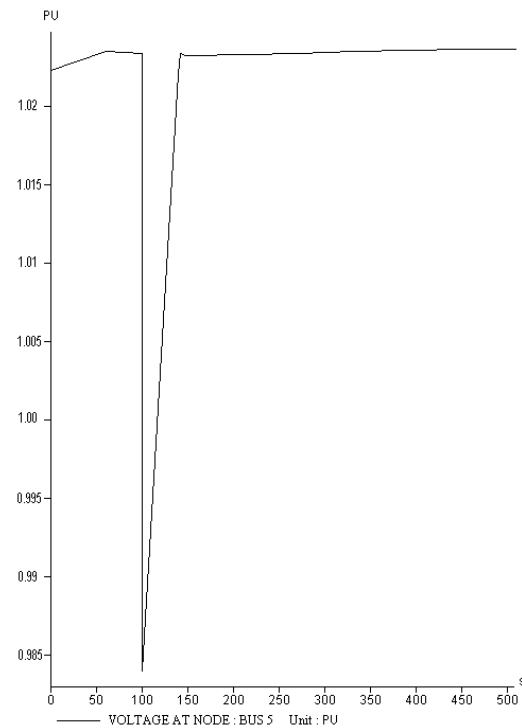

Fig. 5. Voltage change at bus 5 for small load change and low exciter gain

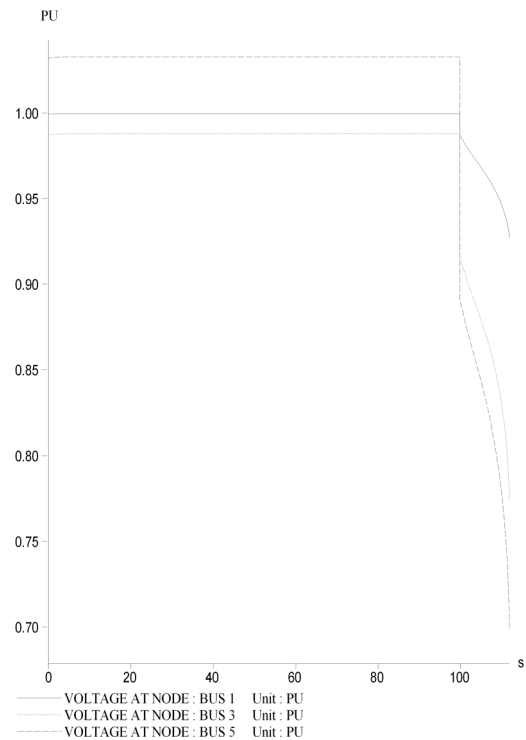

Fig. 7. Voltage collapse when the limit on the reactive power of the generator is low.



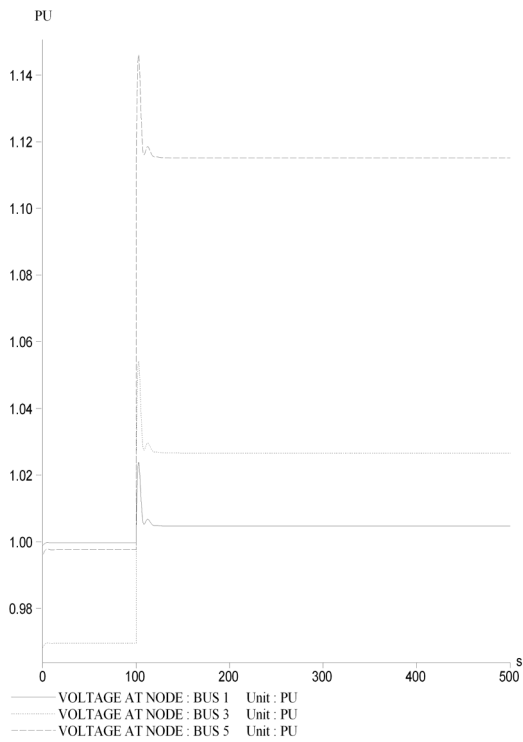

Fig. 8. Response of system with fixed capacitors, to change in load.

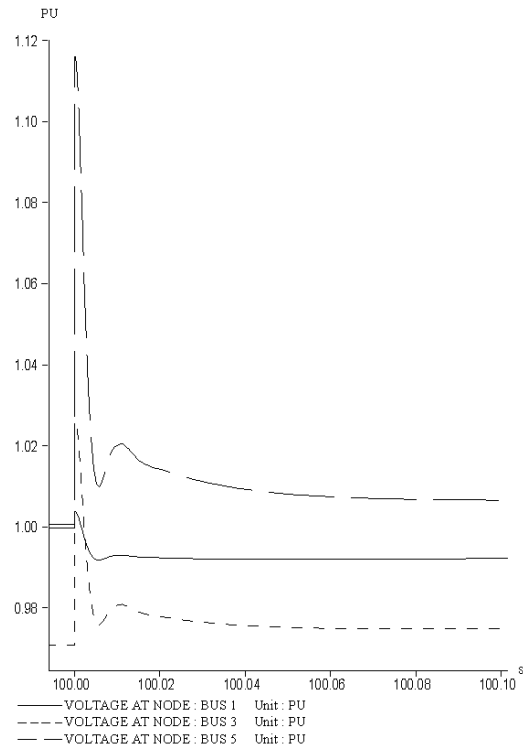

Fig. 10. Response of system with "improved" SVC, to change in load.

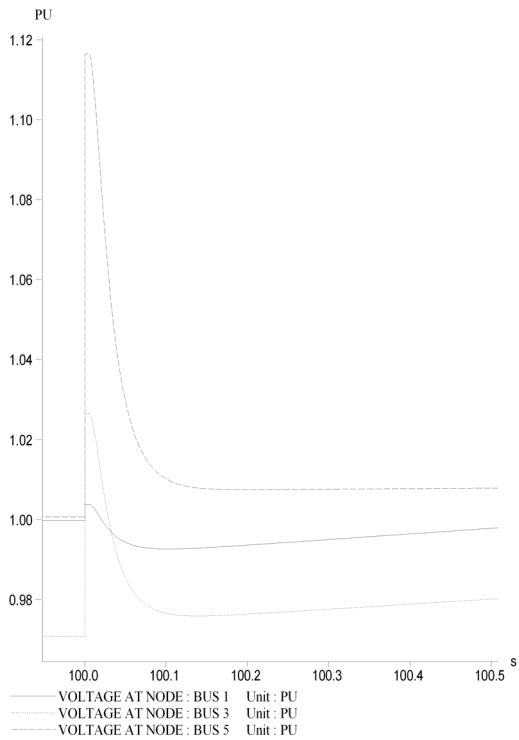

Fig. 9. Response of system with SVC, to change in load.

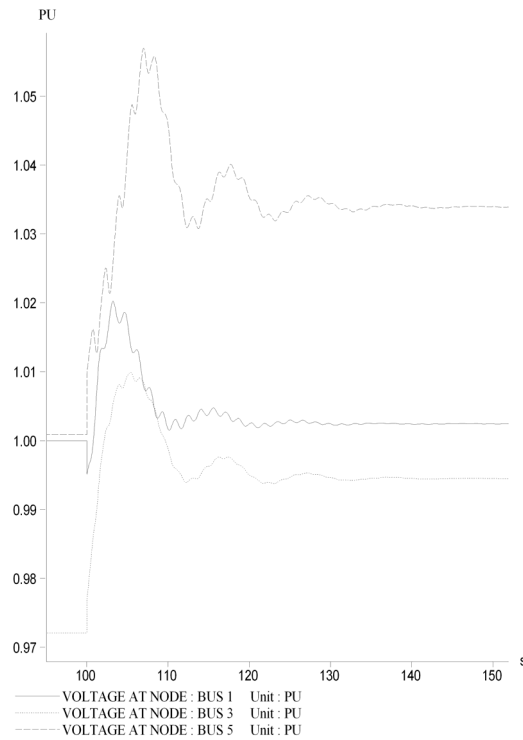

Fig. 11. Response of system with SuperVAR, to change in load.